



# INSTRUCTION



● Thank you for purchasing KOSO mini LCD RPM / engine hour meter, please read the instruction thoroughly before installing.

## ⚠ Notice

- The LCD meter is apply for CR 2032.
- For installation, please follow the steps described in manual. Any damage caused by wrong installation shall be imputed to the users.
- Do not disassemble or change any parts excluding the manual description.
- The interior examination or maintenance should be executed by our professionals.

### ◎ MARK MEANING:

**NOTE** You could get the installation details from the information behind the mark.

⚠ Some processes must be followed to avoid the affection caused by wrong installation.

⚠ **WARNING!** Some processes must be followed to avoid damages to yourself or the public.

⚠ **CAUTION!** Some processes must be followed to avoid the damage to the vehicle.



PRESS THE BUTTON ONE TIME



PRESS THE BUTTON 3 SECONDS

## 1 Accessory

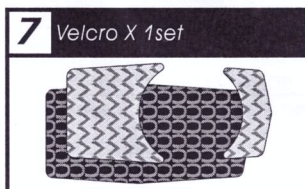
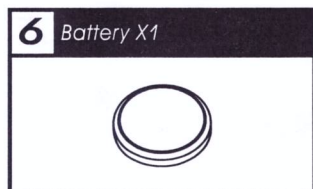
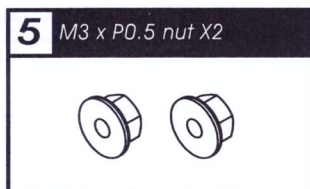
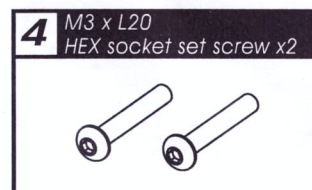
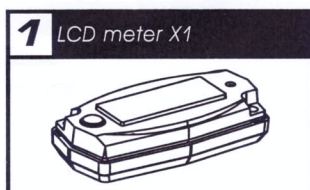

**NOTE** Please contact the local distributor if the items you open are not the same, with the above-listed one.

## 2-1 Installation instructions

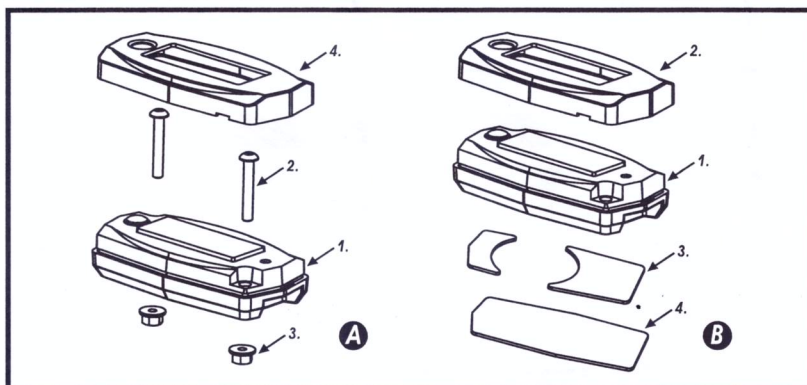

### Follow those steps when installing.

- A**
- 1.LCD meter (Accessory 1)
  - 2.HEX socket set screw (Accessory 4)
  - 3.Nut (Accessory 5)
  - 4.Meter Cover (Accessory 2)
- B**
- 1.LCD meter (Accessory 1)
  - 2.Meter Cover (Accessory 2)
  - 3.Velcro-Male (Accessory 7)
  - 4.Velcro-Female (Accessory 7)

**NOTE** Please choose either Method A or B according to your need to install

## 2-2 Wiring installation instructions

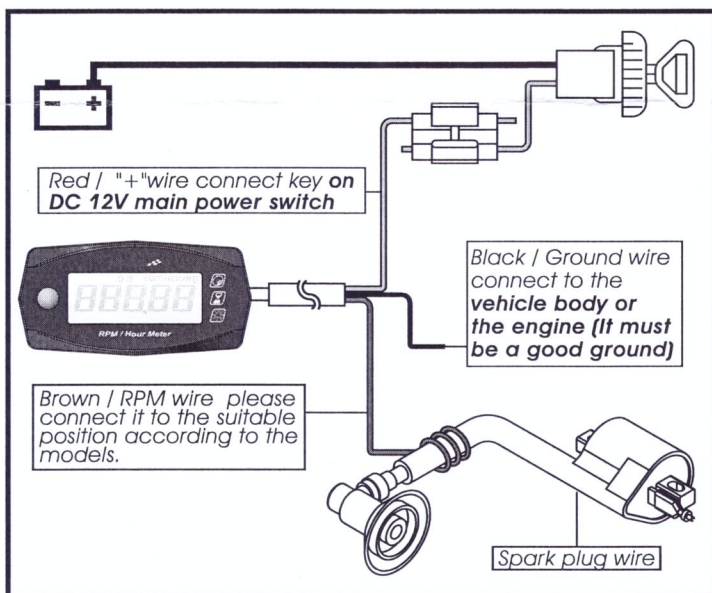

## 2-3 Battery installation instructions

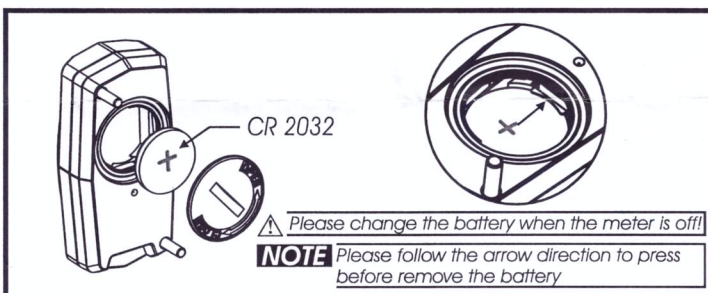

⚠ Please change the battery when the meter is off!  
**NOTE** Please follow the arrow direction to press before remove the battery

## 2-4 New type ignition system

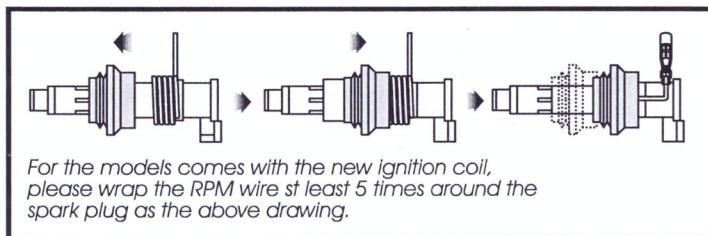

For the models comes with the new ignition coil, please wrap the RPM wire st least 5 times around the spark plug as the above drawing.

### 3 Instruction of function

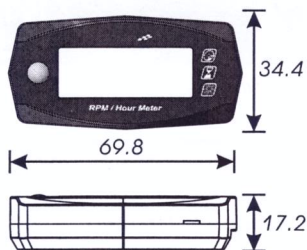

● Digital Tachometer	Display range : 0~15,000 RPM Display unit : 10 RPM <0.5 sec.
○ Display internal	
○ MAX RPM record	Display range: 0~15,000 RPM
○ RPM input pulse	Setting range : 0.5, 1, 1.5, 2, 2.5, 3, 4, 5, 6
● Total engine hour meter	Display range : 0~99999 H Display unit : 1 H
● Hour meter A/B	Display range : 0.0~999.9 H Display unit : 0.1 H
● Supply voltage	<b>DC 12V</b>
● Battery type	<b>CR 2032</b>
● Battery life time	About 350 H (when battery volume below 250 mAh)
● Effective temperature range	-10~60°C
● Meter standard	JIS D 0203
● Meter size	W69.8 X L34.4 X H17.2 mm
● Meter weight	About 47.6g

**NOTE** Design and specifications are subject to change without notice!

### 4 The button function instruction



- In main screen, **press the button one time** to enter the hour meter A.

**CAUTION!** The turn on the meter. The meter will turn on auto-matically when you press the button or there is a signal input.  
The main screen-The meter will turn off automatically if you don't press the button or there is no signal input for 30 seconds.

**NOTE** When the hour meter will start to count the time, the RPM symbol will flash every 0.5 second.



- In the hour meter A screen, **press the button one time** to enter the hour meter B.

- Hold pressing the button for 3 seconds to reset the hour meter A record.



- In the hour meter B screen, **press the button one time** to enter the RPM.

- Hold pressing the button for 3 seconds to reset the hour meter B record.



- In the RPM screen, **press the button one time** to enter the Max. RPM record.



- In the Max. RPM record screen, **press the button one time** to back to the main screen.

- Hold pressing the button for 3 seconds to reset the Max. RPM record.



- The main screen.

**NOTE** The meter will turn off automatically if you don't press the button or there is no signal input for 30 seconds.

### 5 RPM pulse setting



- In RPM screen, hold pressing down the **button** for 3 seconds to enter the RPM pulse setting.



- EX. You want to change the current setting value from 1 to 2.
- In setting screen, press the **button** one time to change the RPM pulse setting value.
- EX. The original setting is 0.5 (4C-1P).

**NOTE** The piston type can be set is : 0.5, 1, 1.5, 2, 2.5, 3, 4, 5, 6.

**Now the RPM pulse setting is flashing!**

The setting value	The corresponding stroke and pistons number	The corresponding RPM signal number per ignition
0.5	4C-1P	2 RPM signals per 1 ignition.
1	2C-1P 4C-2P	1 RPM signal per 1 ignition.
1.5	4C-3P	2 RPM signals per 3 ignition.
2	2C-2P 4C-4P	1 RPM signal per 2 ignition.
2.5	4C-5P	2 RPM signals per 4 ignition.
3	2C-3P 4C-6P	1 RPM signal per 3 ignition.
4	2C-4P 4C-8P	1 RPM signal per 4 ignition.
5	4C-10P	1 RPM signal per 5 ignition.
6	2C-6P 4C-12P	1 RPM signal per 6 ignition.

**CAUTION!** Most of the 4-cycle bikes with one single piston are igniting every 360 degree once, so the setting should be the same as the bike with 2-cycle and one piston engine.



- EX. The Ignition angle setting is changed from 1 to 2 (4C-4P).
- Press down the **button** for 3 seconds, to back the RPM screen.



- The RPM screen.

### 6 Trouble shooting

The following situation do not indicate malfunction of the meter. Please check the following before taking it in for repair.

Trouble	Check item	Trouble	Check item
The meter shows wrong information.	<ul style="list-style-type: none"> <li>● Maybe the problem is caused by the insufficient power →Please change the inner battery. (CR 2032.)</li> <li>● Maybe the problem is caused by wrong battery installation →Please check is the battery direction is correct.</li> </ul>	Tachometer does not appear or appear incorrectly.	<ul style="list-style-type: none"> <li>● Please check the RPM sensor wiring is connected correctly.</li> <li>● Please check the spark plug is R type or not. If not, please replace the spark plug with the R type spark plug.</li> <li>● Please check your setting. →Please refer to the manual 5.</li> </ul>

※If still can't solve the problems according to the steps above, please contact with distributors or us.