



• Thank you for purchasing our product. Before installing/operating the product, read the instructions carefully and retain them for future reference.

⚠ Attention!

- For installation, follow the steps described. Any damage caused by wrong installation shall be imputed to the users.
- To avoid a short circuit from occurring do not pull or modify the wires during installation.
- Do not disassemble or change any parts. Opening and disassembling this unit will void any warranty.
- Maintenance and repairs should be executed by our professionals only.

© Symbol description:



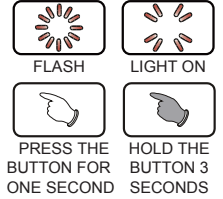

NOTE

⚠ Some procedures must be followed to avoid damages to the instrument.

⚠ **WARNING!** Certain procedure must be followed to avoid damages to yourself, to the vehicle to others.

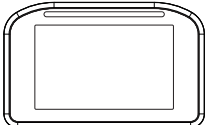
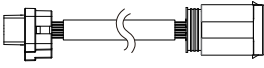
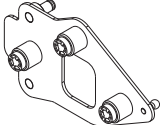

1-1 Accessories

<p>1 LCD Meter X1</p> 	<p>2 Meter harness X1</p> 	<p>3 Meter bracket X1</p> 	<p>4 M4 washer X3</p> 
<p>5 M4 X 10L Bolt X3</p> 	<p>6 4 mm Allen key X1</p> 	<p>7 Outlet cover X1</p> 	

2-1 Vehicle installation instructions

Disassemble in the following order

- 1 The original wiring harness
- 2 LCD Meter

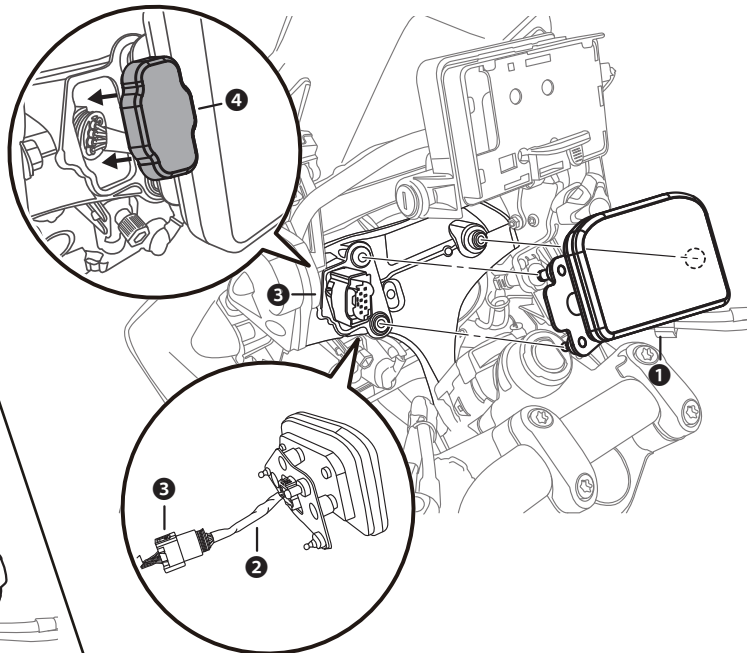

Install in the following order

- 1 LCD Meter (With Bracket and meter harness)
- 2 The meter adapter wiring harness
- 3 The original wiring harness
- 4 Outlet cover

NOTE Refer to the sequence of the drawing for the removal. Perform the assembly in reverse.

⚠ Before assembly, assemble the **1** LCD Meter in advance (refer to 2-2 Installation Instruction).

2-2 Installation instructions

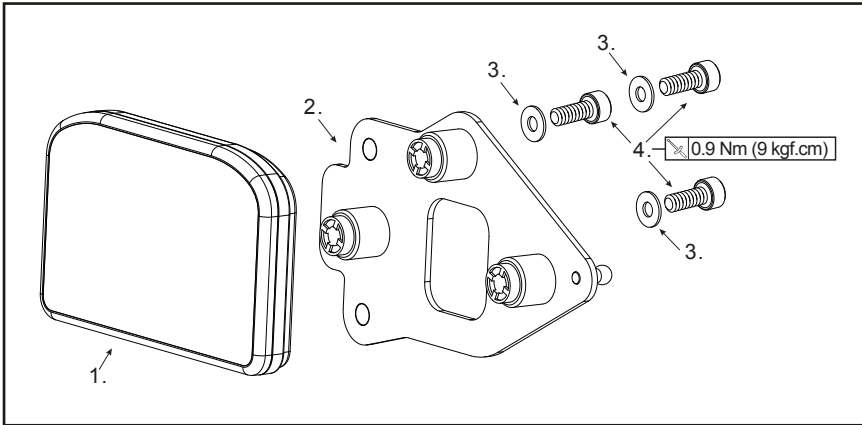

Follow the steps below during installation.

1. LCD Meter (Accessory 1)
2. Meter bracket (Accessory 3)
3. M4 washer X3 (Accessory 4)
4. M4 X 10L Bolt X3 (Accessory 5)

2-3 Wiring Installation Instructions

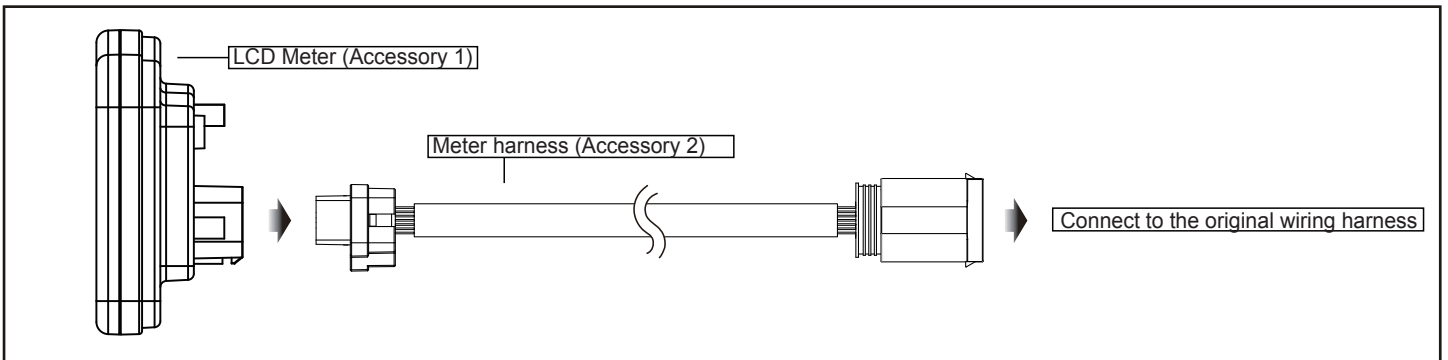

3-1 Meter Size

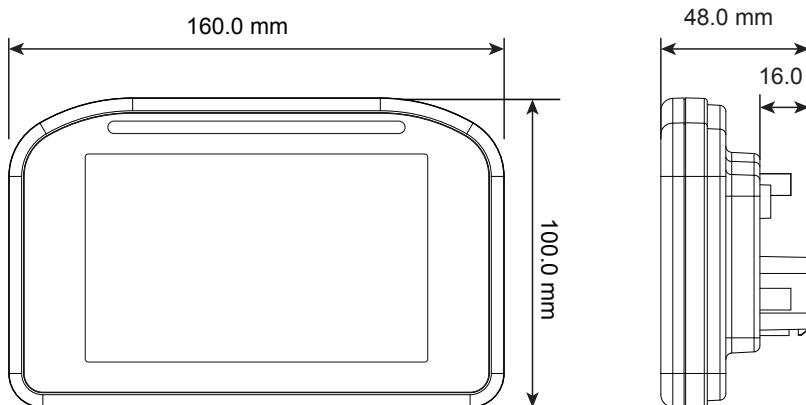

3-2 Button Function Description

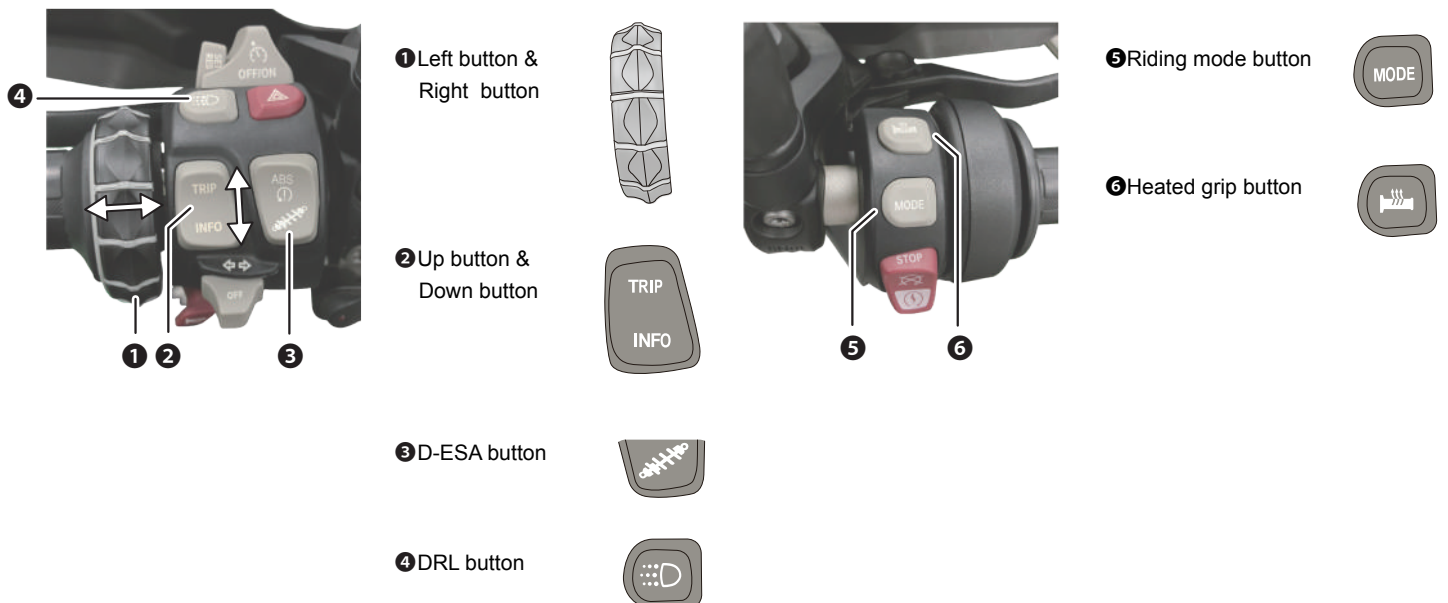

3-3 Basic Function Instructions

DRL

- Display range : Display, No display

DRL(Auto)

- Display range : Display, No display

Hill Start Control

- Display range : Slow Flash, Display, No display

Clock

- Setting range : 00:00 ~ 23:59 (24H), 1:00 ~ 12:59(12H)

Air TEMP

- Display range : -39.5~87.0°C (-39.0~188.0°F)
- Display unit : 0.1 °C (°F)

Heated grip

- Display range : OFF, 50%, 100%

Mobile phone network signal

- Display range : 1~4 segments. (Android supported, iOS not supported.)

Phone battery

- Display range : 1~33%, 2~3 segments. (2 segments=34~66%, 3 segments=67%~100%)
- Display unit : 1%, 1 segment

Bluetooth® connection status

- Display range : Steady(connected), OFF(Not connected)

RPM Light - Start

- Setting range : 1,000~8,000 RPM
- Setting unit : 100 RPM

Shift Light

- Setting range : 2,000~10,000 RPM
- Setting unit : 100 RPM

Pre-Shift Light

- Setting range : 1,000~10,000 RPM
- Setting unit : 100 RPM

Indicator

- Left indicator light(Green)
- Neutral light(Green)
- ASC light(Amber)
- Engine Oil Level Warning(Red)
- Engine light(Amber)
- Right indicator light(Green)
- High beam light(Blue)
- ABS light(Amber)
- Composite warning light(Red/Amber)
- Light sensor & DWA light(Red)

Tachometer

- Display range : 0~10,000 RPM

Speedometer

- Display range : 0 ~ 360 km/h (0 ~ 225 MPH)
- Display unit : 1 km/h (MPH)Switchable

Gear Meter

- Display range : N, 1~ 6

ENGTMP Level

- Display range : Six Level, 0~120°C (32~248°F)
- Display unit : 20°C (36°F)
- Starts from 0°C, and each stage is 20°C (36°F)

Volt Level

- Display range : Six Level, DC 11.5~14.5 V
- Display unit : 0.5V
- Starts from DC 11.5V, and each stage is 0.5V

Fuel Level

- Display range : Six Level, 0~100 %
- Display unit : each stage is 16.6 %

Riding mode

- Display range : RAIN,ROAD, DYNA,ENDURO,ENDURO PRO, DYNA PRO

D-ESA

- Setting range : [Mode] ROAD,DYNA,ENDURO [Strength] MIN,AUTO,MAX

Odometer

- Display range : 0 ~ 99,999 km (mile) and then returns to zero
- Display unit : 1 km (mile)

TRIP 1 and 2

- Display range : 0.0~9,999.9 km (mile), can return to zero manually
- Display unit : 0.1 km (mile)

Trip A (Trip Auto)

- Display range : 0.0~9,999.9 km (mile)
- Display unit : 0.1 km (mile)

Fuel Range

- Display range : 0~999km (mile)
- Display unit : 1km (mile)

CONS R

- Display range : 0~99.9 L/100 km, km/L, MPG(US), MPG(UK)
- Display unit : 0.1 L/100 km, km/L, MPG(US), MPG(UK)

RDC

- Display range : 0.0~3.5 bar(1~50 psi,7~344kPa ,0.0~3.5kg/cm2), ---,-
- Display unit : 0.1 bar(1 psi, 1kPa, 0.1kg/cm2)

Engine Oil Level Warning

- Display range : OK, CHECK, ---

Service Date (SERV T)

- Display range : YYYY.MM.DD; can be reset manually

Service DST (SERV D)

- Display range : -5,000~16,000km (mile); can be reset manually
- Display unit : 1km (mile)

Perpetual calendar

- Setting range (year) : 2021 ~ 2099
- Setting range(month) : 1 ~ 12
- Setting range (day) : 1 ~ 31

RDTIME











- Display range : 0.0~99,999.9 hr and then return to zero
- Display unit : 0.1 hr

Time 1,2

- Display range : 0.0~9,999.9 hr and then returns to zero ; can also return to zero manually
- Display unit : 0.1 hr

3-4 Specifications(Meter)

●Speedometer	Display range : 0 ~ 360 km/h (0 ~ 225 MPH) Display unit : 1 km/h (MPH) Switchable	●CONS C	Display range : 0~99.9 L/H, G/H Display unit : 0.1 L/H, G/H
●Odometer	Display range : 0 ~ 99,999 km (mile) and then returns to zero Display unit : 1 km (mile)	●ØCONS	Display range : 0~99.9 L/100km, km/L, MPG(US), MPG(UK) Display unit : 0.1 L/100km, km/L, MPG(US), MPG(UK)
●Trip A (Trip Auto)	Display range : 0.0~9,999.9 km (mile) Display unit : 0.1 km (mile)	●Fuel 1, 2	Display range : 0~9999.9 L, G, can be returned to zero manually Display unit : 0.1L, G
●TRIP 1, 2	Display range : 0.0~9,999.9 km (mile), can be returned to zero manually Display unit : 0.1 km (mile)	●Ø CONS 1, 2	Display range : 0~99.9 L/100km, km/L, MPG(US), MPG(UK), can be returned to zero manually. Display unit : 0.1 L/100km, km/L, MPG(US), MPG(UK)
●RDTIME	Display range : 0~99,999.9 hr and then returns to zero Display unit : 0.1 hr	●CONS R	Display range : 0~99.9 L/100km, km/L, MPG(US), MPG(UK) Display unit : 0.1 L/100km, km/L, MPG(US), MPG(UK)
●Time 1, 2	Display range : 0.0~9,999.9 hr and then returns to zero ; can also return to zero manually Display unit : 0.1 hr	●Date	Setting range (year) : 2021 ~ 2099 Setting range (month) : 1 ~ 12 Setting range (day) : 1 ~ 31
●MAX Speed	Display range : 0~360 km/h (0~225MPH) Display unit : 1 km/h (MPH)	●Clock	Setting range : 00:00 ~ 23:59 (24H), 01:00 ~ 12:59(12H)
●Ø Speed	Display range : 0~360 km/h (0~225MPH) Display unit : 1 km/h (MPH)	●Voltmeter	Display range : DC 8.0~18.0 V Display unit : DC 0.1 V
●Ø Speed 1, 2	Display range : 0~360 km/h (0~225MPH), can be returned to zero manually Display unit : 1 km/h (MPH)	●Volt Level	Display range : Six Levels, DC 11.5~14.5 V Display unit : Starts from DC 11.5V, and each stage is 0.5V
●Cruise Control	Display range : ON(Display) · OFF(No display)	●Low voltage warning	Setting range : DC 8.0~13.0 V Setting range : DC 0.1 V
●Service Date(SERV T)	Display range : YYYY.MM.DD; can be reset manually Setting range : 1~24 month Setting unit : 1 month	●High voltage warning	Setting range : DC 13.1~18.0 V Setting range : DC 0.1 V
●Service DST(SERV D)	Display range : -5,000~16,000km (mile); can be reset manually Display unit : 1km (mile) Setting range : 0~16,000km (mile) Setting unit : 100km (mile)	●Warning for the charging of storage battery	Display range : CHECK
●Gear Meter	Display range : N, 1~ 6	●Tire pressure	Display range : 0.0~3.5 bar(1~50 psi ~ 7~344kPa, 0.0~3.5kg/cm2), --- Display unit : 0.1 bar(1 psi, 1kPa, 0.1kg/cm2)
●Max. Gear record	Display range : N, 1 ~ 6, can be returned to zero manually	●Tire pressure warning	Display range : normal, tire pressure reaching the permitted scope of tolerance, excessive tire pressure RDC abnormal
●Recommendation to up-shift	Display range : Display, No display Setting range : ON, OFF	●RDC	Display range : RDC
●Hill Start Control	Display range : Slow Flash, Display, No display	●Heated grip	Display range : OFF, 50%, 100%
●Tachometer	Display range : 0~10,000 RPM	●DRL	Display range : Display, No display
●RPM Light - Start	Setting range : 1,000~8,000 RPM Setting unit : 100 RPM	●DRL(Auto)	Display range : Display, No display Setting range : ON, OFF
●Shift Light	Setting range : 2,000~10,000 RPM Setting unit : 100 RPM	●Lamp Warning	Display range : LAMP R, LAMP F, LAMP S
●Pre-Shift Light	Setting range : 1,000~10,000 RPM Setting unit : 100 RPM	●EWS	Display range : CHECK, OUTRG, KEYLO
●MAX RPM	Display range : 0~10,000 RPM	●Mobile phone network signal	Display range : 1~4 segments (Android supported, iOS not supported.)
●ALTIME	Display range : 0~99,999.9 hr and then returns to zero Display unit : 0.1 hr	●Phone battery	Display range : 1~33%, 2~3 segments (2 segments=34~66%, 3 segments=67%~100%) Display unit : 1%, 1 segment
●Coding Plug	Display range : Display, No display	●Bluetooth® connection status	Display range : Steady(connected), OFF(Not connected)
●Riding mode	Display range : RAIN, ROAD, DYNA, ENDURO, ENDURO PRO, DYNA PRO	●Push notification	Display range : Name : One line; no display when exceeding the range Content : One line; no display when exceeding the range (iOS supported, Android not supported.)
●D-ESA	Setting range : [Mode] ROAD, DYNA, ENDURO [Strength] MIN, AUTO, MAX	●Turning precaution	Display range : A total of 40 turning precautions (Android supported, iOS not supported.)
●Warning for the malfunction of E-ESA control element	Display range : D-ESA	●Estimated turning distance	Display range : 0~999m, 1~999km (0~528ft, 0.1~999.9mile) Display unit : 1m, 1km (1ft, 0.1mile) (Android supported, iOS not supported.)
●Engine Oil Level warning	Display range : OK, CHECK, ---	●Estimated turning road	Display range : Three lines; "... " will be displayed when exceeding the range (Android supported, iOS not supported.)
●Digital ENG Thermometer	Display range : 0.0~250.0°C (32.0~482°F) Display unit : 0.1 °C (°F)	●Estimated arrival time	Display range : 00:00 ~ 23:59 (24H) · 1:00 ~ 12:59 (12H) (Android supported, iOS not supported.)
●ENGTMP Level	Display range : Six Level, 0~120°C (32~248°F) Display unit : Starts from 0°C, and each stage is 20°C	●Estimated arriving distance	Display range : 0~999m · 1~999km (0~528ft · 0.1~999.9mile) Display unit : 1m · 1km (1ft · 0.1mile) (Android supported, iOS not supported.)
●ENGTMP warning	Setting range : 60~250 °C (140~482°F) Setting unit : 1 °C (°F)	●Call History	Display range : Record eight incoming calls received after connecting with the mobile.
●MAX ENGTMP	Display range : 0~250 °C (32~482°F)	●Incoming phone call notice	Display range : name or number ; "No Caller ID" is displayed when there is no name or number.
●Warning for overheated engine	Display range : OVER HEAT		
●Air TEMP.	Display range : -39.5~87.0°C (-39.0~188.0°F) Display unit : 0.1 °C (°F)		
●Black Ice warning	Display range : -39.5~4.5°C (-39.0~40.0°F) Display unit : 0.1 °C (°F)		
●Engine failure warning	Display range : ! CHECK, !! CHECK, CHECK		
●Fuel meter	Display range : 0~100 % Display unit : 1%		
●Fuel Level	Display range : Six Levels, 0~100 % Display unit : each stage is 16.6 %		
●Fuel warning setting	Setting range : 10~50 % Setting unit : 10 %		
●Fuel Range	Display range : 0~999km (mile) Display unit : 1km (mile)		

<ul style="list-style-type: none"> ● Incoming online app call notice 	Display range : name ; "No Caller ID" is displayed when there is no name. For online calls of the Android system, whether the calls get through or not, the display will disappear after 10 seconds. (supported : LINE, Messenger, WeChat, Whats App)	<ul style="list-style-type: none"> ● Back light brightness (Night) 	Setting range : 1/5~ 5/5, shall be \leq the setting value of the backlight brightness (daytime) Setting unit : 1/5
<ul style="list-style-type: none"> ● Call time 	Display range : 00:00~59:59, "59:59+" will be displayed when exceeding the range.	<ul style="list-style-type: none"> ● LED brightness (Day) 	Setting range : 1/5~ 5/5 Setting unit : 1/5
<ul style="list-style-type: none"> ● Song title 	Display range: Three lines; "... " will be displayed when exceeding the range.	<ul style="list-style-type: none"> ● LED brightness (Night) 	Setting range : 1/5~ 5/5, shall be \leq the setting value of the LED brightness (daytime) Setting unit : 1/5
<ul style="list-style-type: none"> ● Artist name 	Display range: One line; no display when exceeding the range	<ul style="list-style-type: none"> ● Unit 	Speed unit : km/h , MPH Temperature unit : °C (Celsius) and °F (Fahrenheit) Tire pressure unit : bar, psi, kPa, kg/cm2 CONS unit : L/H, G/H Ø CONS unit : L/100km, km/L, MPG (UK), MPG (US)
<ul style="list-style-type: none"> ● Total length of the song 	Display range: 00:00~59:59 ; "59:59+" will be displayed when exceeding the range (iOS supported, Android not supported.)	<ul style="list-style-type: none"> ● Voltage 	DC 12 V
<ul style="list-style-type: none"> ● Current play time 	Display range: 00:00~59:59 ; "59:59+" will be displayed when exceeding the range (iOS supported, Android not supported.)	<ul style="list-style-type: none"> ● Operating temperature 	-20~ 85 °C
<ul style="list-style-type: none"> ● Current play time progress bar 	Display range: Bar display from 0 to 100% (current play time/total time length of the music) (iOS supported, Android not supported.)	<ul style="list-style-type: none"> ● Storage temperature 	-30~ 90 °C
<ul style="list-style-type: none"> ● Previous song 	(iOS supported, Android not supported.)	<ul style="list-style-type: none"> ● Specification 	JIS D 0203 (S2)
<ul style="list-style-type: none"> ● Next song 	(iOS supported, Android not supported.)	<ul style="list-style-type: none"> ● Meter Size 	453.5 x 283.5 x 136.0 mm
<ul style="list-style-type: none"> ● Play / Pause 	(iOS supported, Android not supported.)	<ul style="list-style-type: none"> ● Meter Weight 	Around 320 g
<ul style="list-style-type: none"> ● Volume +/- 	Display range: 0~100%	<ul style="list-style-type: none"> ● Indicator 	Left indicator light (Green)  Neutral light (Green)  ASC light (Amber)  Engine Oil Level Warning (Red)  Engine light (Amber)  Right indicator light (Green)  High beam light (Blue)  ABS light (Amber)  Composite warning light (Red/Amber)  Light sensor & DWA light (Red) 
<ul style="list-style-type: none"> ● Background display 	Setting range : Auto(automatically switch according to ambient light : day mode display for a bright environment and Night mode display for a dark environment), Day mode, Night mode.	NOTE Design and specifications are subject to change without notice.	
<ul style="list-style-type: none"> ● Back light brightness (Day) 	Setting range : 1/5~ 5/5 Setting unit : 1/5		

4-1 Start screen for Initial Use

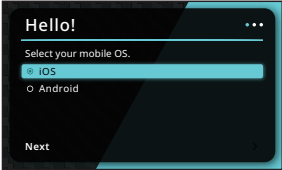

- Start screen for Initial Use, press the **Up or Down button** to choose mobile phone operating system.
- Press the **Right button** to confirm the mobile phone operating system.



- EX : Set date from 2021.01.01 to 2021.06.25.
- Press the **Right button** to confirm the selection.
- Press the **Down button** to go to the time setting.

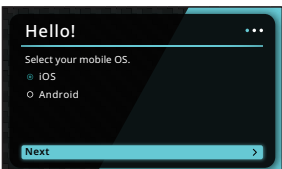

- Press the **Right button**, enter the Bluetooth® pairing screen.
- EX : Select iOS for mobile phone operating system

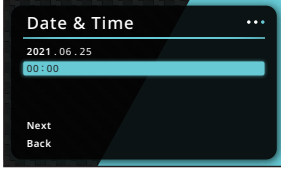

- **Example : To set time as 10:00.**
- Press the **Right button** to enter time setting.
- Press the **Right button** to move to the digit you want to set.
- Press the **Up(Accumulate) or Down(Decrease) button** to choose the setting number.

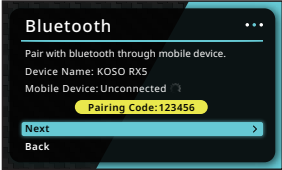

- Need to enter the pairing code.

NOTE iOS operating system: Need to enter the pairing code.
 Android operating system: No pairing code is required. Enter vehicle type selection directly.



- Press the **Right button** to confirm the selection.



- Press the **Right button**, enter the Date & time setting screen.
- EX : Bluetooth® pairing screen completed.

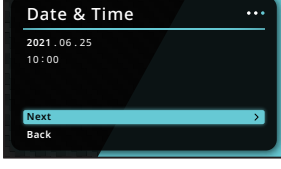

- Select Next, press the **Right button** to go to the next setting.
- Select Back, press the **Right button** to return to Bluetooth® settings.

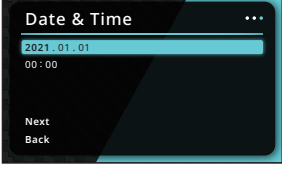

- **Example : To set date to 2021.06.25.**
- Press the **Right button** to enter date setting.
- Press the **Right button** to move to the digit you want to set.
- Press the **Up(cumulative) or Down(Decrease) button** to choose the setting number.



- Select GO! Press the **Right button** to go to the main screen.
- Select Settings, press the **Right button** to go to the setting screen.

4-2 Menu Switching Description

Switch screens



⚠ When not connecting to Bluetooth®, the screen may not be shifted to the music, navigation, or historical call history screen.

⚠ For driving safety, when the vehicle is moving, the screen may not be shifted to the mode screen.

Tab

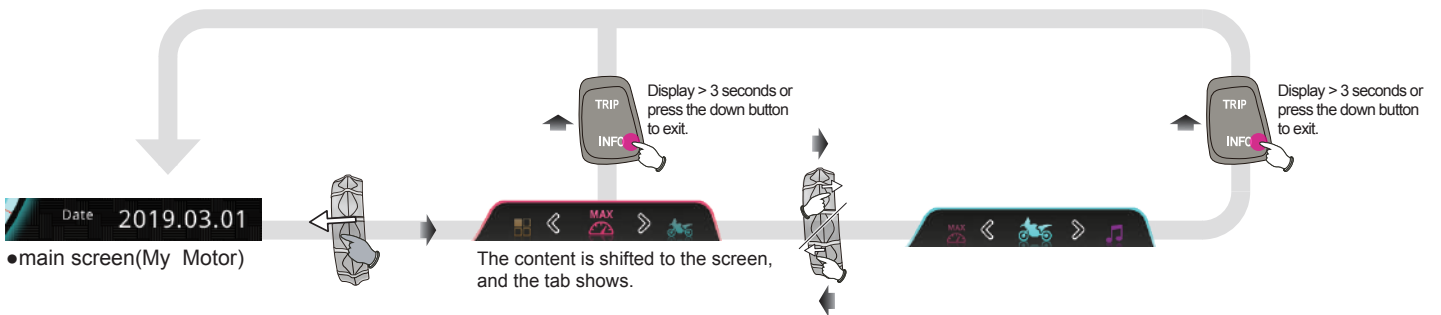

NOTE Exit the tab when the tab is displayed for more than three seconds or by pressing the down button.

⚠ After the tab shows, functions of other buttons will become invalid, and such functions will be resumed upon exiting the tab.

⚠ When not connected to Bluetooth®, music will not be displayed on the tab.

4-3-1 Main Menu Switching Description(TRIP button)

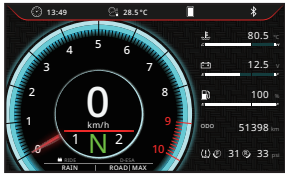

- In the ODO screen, press the **Up button** to enter the Trip 1 screen.
- Press the **Up button for 3 seconds**, enter the mode screen rapidly.

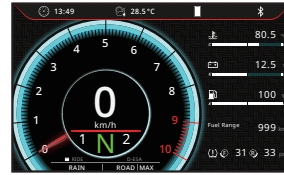

- In the Fuel Range screen, press the **Up button** to enter the CONS R screen.

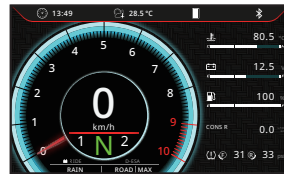
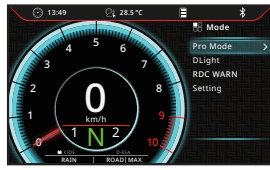
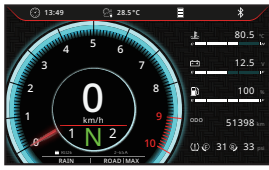

- In the CONS R screen, press the **Up button** to go back to the ODO screen.

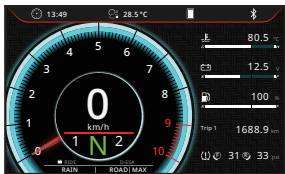

- In the Trip 1 screen, press the **Up button** to enter the Trip 2 screen.
- Press the **Up button for 3 seconds** to reset Trip 1 record.

Trip 1 1688.9 km → Trip 1 0.0 km

NOTE Records in the Record 1 information tab will be cleaned at the same time.

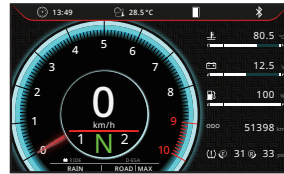

- In the ODO screen.

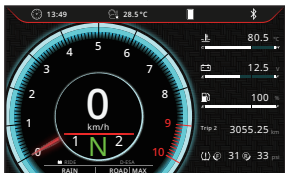

- In the Trip 2 screen, press the **Up button** to enter the Trip A (Auto) screen.
- Press the **Up button for 3 seconds** to reset Trip 2 record.

Trip 2 3055.5 km → Trip 2 0.0 km

NOTE Records in the Record 2 information tab will be cleaned at the same time.

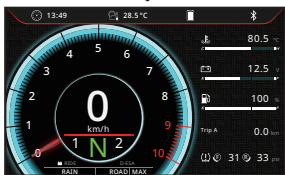

- In the Trip A (Auto) screen, press the **Up button** to enter the Fuel Range screen.

4-3-2 Main Menu Switching Description(INFO button)



- In the Tire pressure screen, press the **Down button** to enter the oil level (OILLVL) screen.

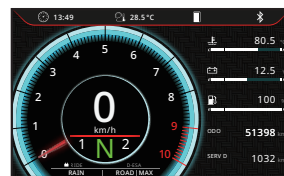

- In the Service DST (SERV D) screen, press the **Down button** to enter the Date screen.

- Press the **Down button for 3 seconds** to reset Service DST (SERV D) record.

SERV D 1032 km → SERV D 10000 km



- In the oil level (OILLVL) screen, press the **Down button** to enter the Service Date(SERV T) screen.



- In the Date screen, press the **Down button** to enter the ALTIME screen.



- In the Service Date(SERV T) screen, press the **Down button** to enter the Service DST (SERV D) screen.
- Press the **Down button for 3 seconds** to reset Service Date(SERV T) record.

SERV T 2022.01.01 → SERV T 2023.01.01

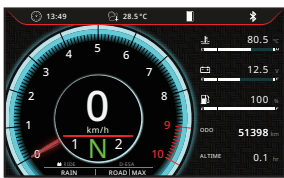

- In the ALTIME screen, press the **Down button** to enter the TIME 1 screen.
- Press the **Down button for 3 seconds** to enter the Record screen.

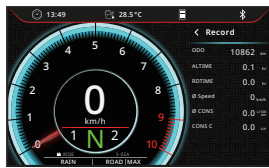
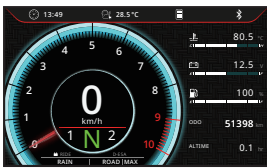

- In the TIME 1 screen, press the **Down button** to enter the TIME 2 screen.
- Press the **Down button for 3 seconds** to enter the Record 1 screen.

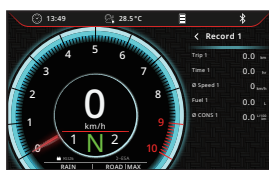

- In the TIME 2 screen, press the **Down button** to go back to the Tire pressure screen.
- Press the **Down button for 3 seconds** to enter the Record 2 screen.

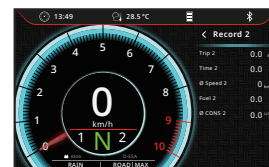

- In the Tire pressure screen.



- Warning List screen.
- Press the **Down button for 3 seconds** to enter the Warning List screen.

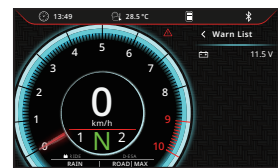
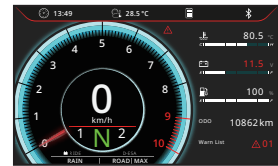

NOTE The list of warnings is displayed when there is a warning.

4-3-3 Main Menu Switching Description(MODE button)

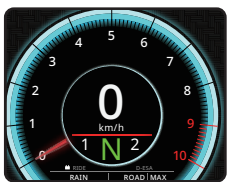

- Press the **MODE button** to enter the setting.



- Example : To set Riding mode to ROAD.
- Press the **MODE button** to choose the setting options.

⚠ Now the setting value is flashing.

NOTE Display range : RAIN, ROAD, DYNA, ENDURO, ENDURO PRO, DYNA PRO.



- EX : Set Riding mode from RAIN to ROAD.

4-3-4 Main Menu Switching Description (D-ESA button)



- Press the **D-ESA** button to enter the setting.



- **Example** : To set D-ESA [Strength] to **MIN**.
 - Press the **D-ESA** button for **3 seconds** to choose the setting options.
- ⚠** Now the setting value is flashing!

NOTE Setting range : [Strength] MIN, AUTO, MAX.



- **Example** : To set D-ESA [Mode] to **DYNA**.
 - Press the **D-ESA** button to choose the setting options.
- ⚠** Now the setting value is flashing.

NOTE Setting range : [Mode] ROAD, DYNA, ENDURO.



- **EX** : Set D-ESA [Strength] from **MAX** to **MIN**.



- **EX** : Set D-ESA [Mode] from **ROAD** to **DYNA**.

4-3-5 Main Menu Switching Description (Heated grip button)



- **Example** : To set Heated grip to **100 %**.
 - Press the **Heated grip** button to choose the setting options.
- NOTE** Setting range : OFF, 50%, 100%.
Default value : OFF.
- NOTE** enter the mode screen rapidly.

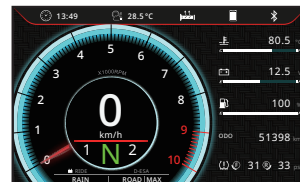

- **EX** : Set Heated grip from **OFF** to **100 %**.

4-3-6 Main Menu Switching Description (DRL button)



- **Example** : To set **DRL** to **ON**.
 - Press the **DRL** button to choose the setting options.
- NOTE** Setting range : ON, OFF.

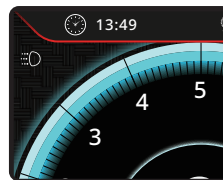

- **EX** : Set **DRL** from **OFF** to **ON**.

4-4 Music

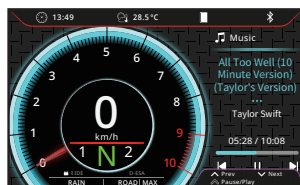

- Music playing screen.
- Press the **Up** button to go back to the previous song.
- Press the **Down** button to go to the next song.
- Press the **Up** button for **3 seconds**, Play / Stop music.
- Press the **Left** or **right** button to adjust the volume.

NOTE **Song title** : Three lines; "... " will be displayed when exceeding the range.
Artist name : One line; no display when exceeding the range.
Total length of the song : 00:00~59:59, "59:59+" will be displayed when exceeding the range.
 → iOS supported, Android not supported.
Current playing time : 00:00 ~ 59:59 "59:59+" will be displayed when exceeding the range.
 → iOS supported, Android not supported.
Current playing time progress bar : Bar display from 0 to 100%.
 (current playing time/total time length of the music)
 → iOS supported, Android not supported.
Previous song : iOS supported, Android not supported.
Next song : iOS supported, Android not supported.
Play / Stop : iOS supported, Android not supported.
Volume +/- : 0~100%, iOS supported, Android not supported.

4-5 Navigation

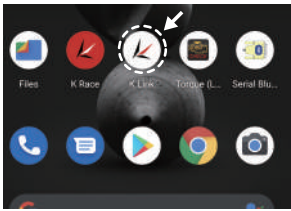

●Install the K Link APP from Play Store on your mobile phone and press to enter the APP.

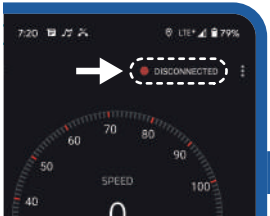
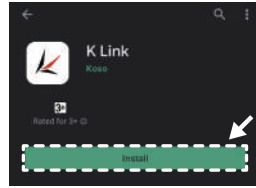

●Press the circled part.

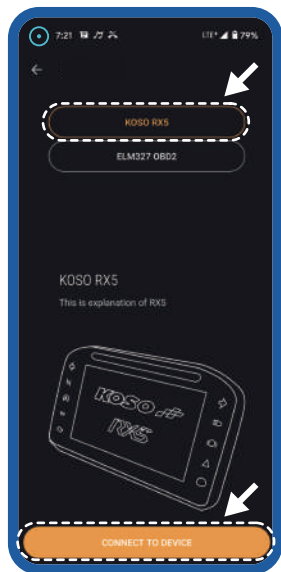

●Press device "KOSO RX5."
●Press device "CONNECT TO DEVICE."

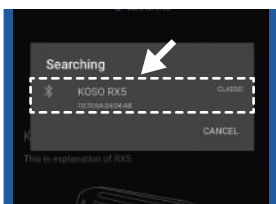

●Press the circled part.

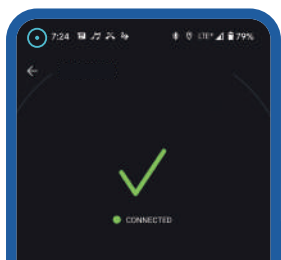

●Successfully connected.

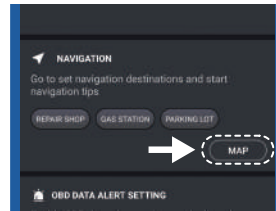

●Press device "MAP."



●Enter the location you intend to visit.

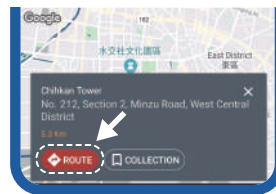

●Press device "ROUTE."

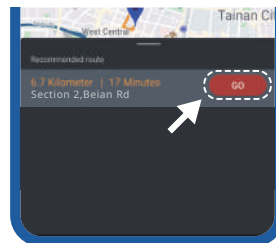

●Press device "GO."



●Mobile navigation screen.

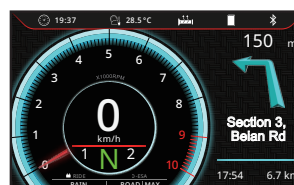

●Meter navigation screen.

NOTE Turning precaution : A total of 40 turning precautions.
Estimated turning distance : 0~999m,1~999km (0~528ft,0.1~999.9mile).
Estimated turning road : Three lines; "... " will be displayed when exceeding the range.
Estimated arrival time : 00:00 ~ 23:59 (24H),1:00 ~ 12:59 (12H)
Estimated arriving distance : 0~999m,1~999km (0~528ft, 0.1~999.9mile).
 →(Android supported, iOS not supported.)

4-6 Call History

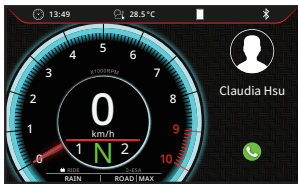

- Incoming phone call notice screen.
- Incoming online call notice screen.

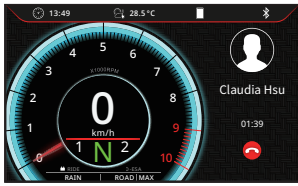

Call ending screen.

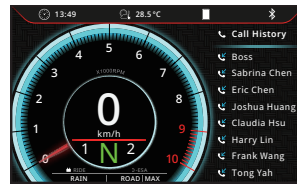

- Call history screen.

NOTE **Call History** : Record eight incoming calls received after connecting with the mobile.
Incoming phone call notice : name or number ; "No Caller ID" is displayed when there is no name or number.
Incoming online app call notice : name ; "No Caller ID" is displayed when there is no name.
 For online calls of the Android system, whether the calls get through or not, the display will disappear after 10 seconds.
 →supported : LINE, Messenger, WeChat, Whats App.
Call time : 00:00~59:59, "59:59+" will be displayed when exceeding the range.

4-7 MAX Record

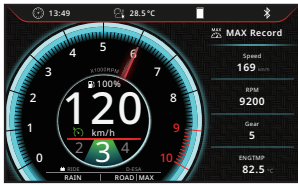

- MAX record screen.

● Press the **Down** button for 3 second to Clear MAX record.

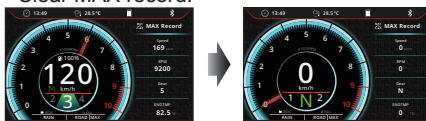

4-8 Mode

4-8-1 — Pro Mode

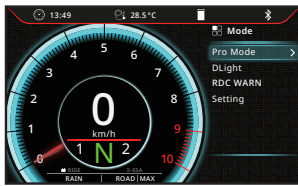

- Press the **Right** button to enter Pro Mode setting.

NOTE This is an existing function from the original supplier; perform the setting according to the recommendations in the manual provided by the original supplier.

4-8-2 — D Light

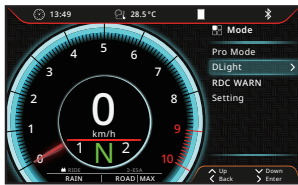

- Press the **Right** button to enter D Light setting.

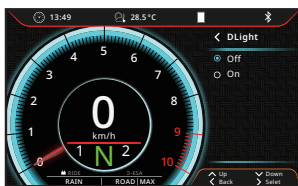

- **Example** : To set D Light to on.
- Press the **Up** or **Down** button to choose the setting options.
- Press the **Right** button to confirm the selection.

NOTE Display range : on, off. Default value : on.



- **EX** : Set D Light from off to on.
- Press the **Left** button to go back to the Mode screen.

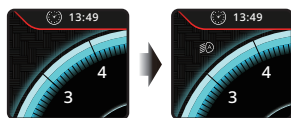

- In the Mode screen.

4-8-3 — RDC WARN

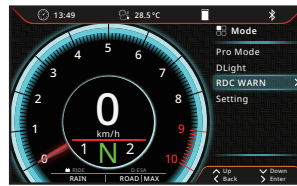

- Press the **Right** button to enter RDC WARN setting.

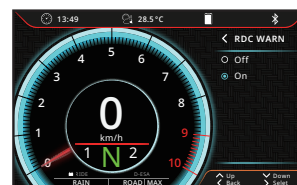

- **Example** : To set RDC WARN to off.
- Press the **Up** or **Down** button to choose the setting options.
- Press the **Right** button to confirm the selection.

NOTE Display range : on, off. Default value : on.

⚠ Switch the riding mode to ENDURO or ENDURO PRO to turn off the tire pressure warning.

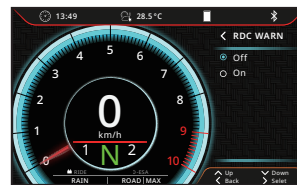

- **EX** : Set RDC WARN from on to off.
- Press the **Left** button to go back to the Mode screen.

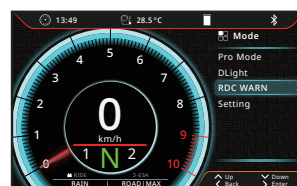

- In the Mode screen.

4-8-4 — Setting

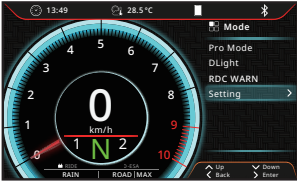

● Press the **Right button** to enter setting screen.

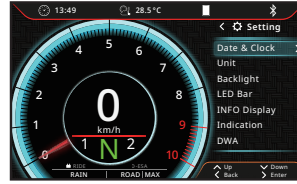

● In the setting screen.

5 Setting Screen Switching Description

- Press the **Right button** on setting mode screen to enter the setting screen.
- Press the **Up button** or **Down button** to select
- ① Date & Clock ② Unit ③ Backlight ④ LED Bar ⑤ INFO Display ⑥ Indication ⑦ DWA ⑧ Shift Light ⑨ Low Fuel Alert ⑩ ENG TMP Alert
- ⑪ Volt WARN ⑫ ODO ⑬ Maintenance ⑭ About RX5 ⑮ Bluetooth®
- Press the **Right button** to enter setting function screen.

NOTE During setting, if any button is not pressed for 3 minutes, it will automatically return to the startup screen.

● Main screen

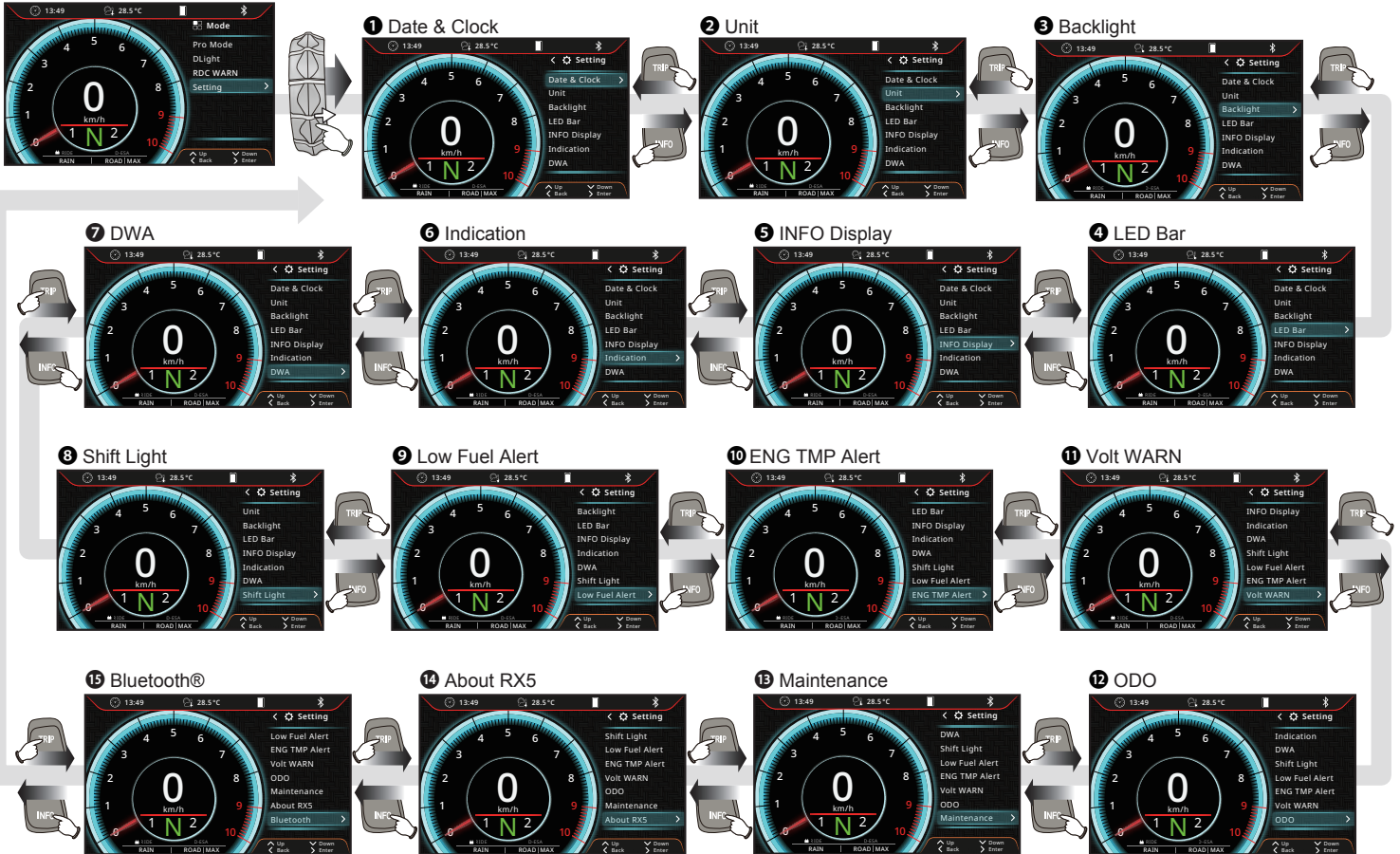

5-1 Date & Clock Setting

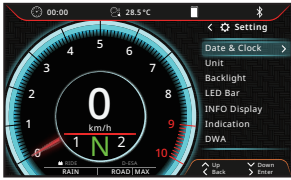

- The Date & Clock screen, press the **Right button** to enter the Date & Clock setting.

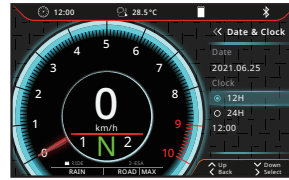

- EX : Set time format from 24 H to 12 H.
- Press the **Down button** to go to the time adjustment setting.

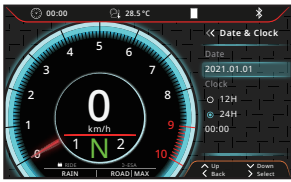

- Press the **Right button** to enter the Date setting.
- Example** : To set Date to 2021.06.25.

⚠ Now the setting value is flashing!

NOTE Setting range (year) : 2021 ~ 2099
Setting range (month) : 1 ~ 12
Setting range (day) : 1 ~ 31

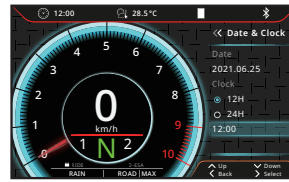

- Press the **Right button** to enter the time adjustment setting screen.

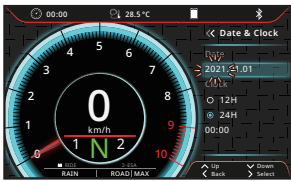

- Press the **Up or Down button** to choose the setting number.
- Press the **Right button** to confirm the selection.

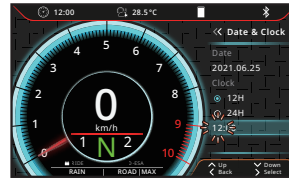

- Example** : To set clock as 10:10 PM.
- Press the **Up or Down button** to choose the setting number.
- Press the **Right button** to confirm the selection.

⚠ Now the setting value is flashing!

NOTE Cursor moving order is :
Hour → Minutes

NOTE Setting range : 00:00 ~ 23:59 (24H)
/01:00 ~ 12:59(12H).
Default value :
00:00(24H)/12:00(12H)

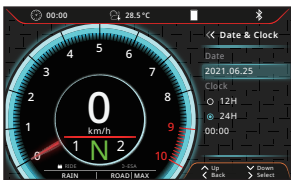

- EX : Set Date from 2021.01.01 to 2021.06.25.
- Press the **Down button** to go to the Clock setting.



- EX : Set Clock from 12:00 AM to 10:10 PM.
- Press the **Left button** to go back to the Date & Clock screen.



- Example** : Changing the 12H.
- Press the **Up or Down button** to choose the setting options.
- Press the **Right button** to confirm the selection.

⚠ Now the setting value is flashing!

NOTE Setting range : 12 H, 24 H.
Default value : 24 H.

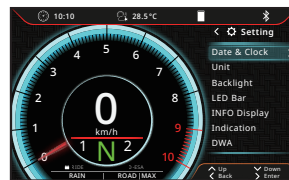

- The Date & Clock screen.

5-2 Unit Setting

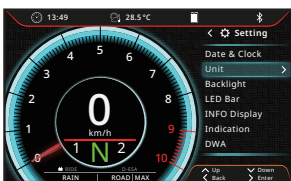

- The unit screen, press the **Right button** to enter the unit setting.



- EX : Set speed unit from km/h to MPH.
- Press the **Down button** to go to the temp. unit setting screen.



- Example** : To set speed unit to MPH
- Press the **Up or Down button** to choose the setting options.
- Press the **Right button** to confirm the selection.

NOTE Setting range : km/h, MPH.
Default value : km/h.



- Example** : To set Temperature unit to °F.
- Press the **Up or Down button** to choose the setting options.
- Press the **Right button** to confirm the selection.

NOTE Setting range : °C (Celsius) and °F (Fahrenheit).
Default value : °C (Celsius).

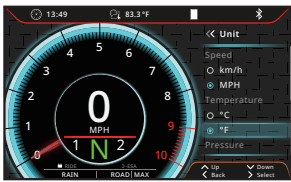

- EX : Set temperature unit from °C to °F.
- Press the **Down button** to go to the Pressure unit setting screen.

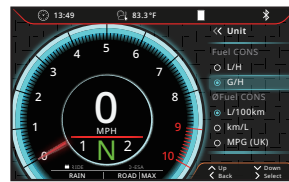

- EX : Set Fuel CONS unit from L/H to G/H.
- Press the **Down button** to go to the ØFuel CONS unit setting screen.

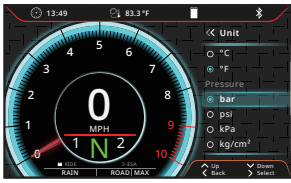

- Example** : To set Pressure unit to psi.
- Press the **Up or Down button** to choose the setting options.
- Press the **Right button** to confirm the selection.

NOTE Setting range : bar, psi, kPa, kg/cm².
Default value : bar.

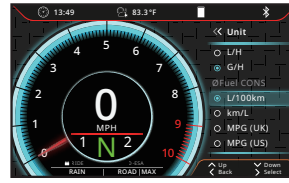

- Example** : To set ØFuel CONS unit to km/L.
- Press the **Up or Down button** to choose the setting options.
- Press the **Right button** to confirm the selection.

NOTE Setting range : L/100km, km/L, MPG (UK), MPG (US).
Default value : L/100km.

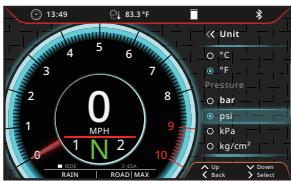

- EX : Set Pressure unit from bar to psi.
- Press the **Down button** to go to the Fuel CONS unit setting screen.

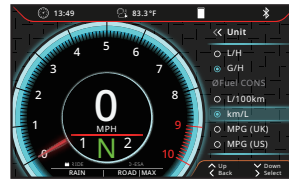

- EX : Set ØFuel CONS unit from L/100km to km/L.
- Press the **Left button** to go back to the unit screen.

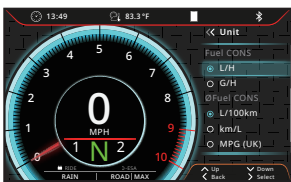

- Example** : To set Fuel CONS unit to G/H.
- Press the **Up or Down button** to choose the setting options.
- Press the **Right button** to confirm the selection.

NOTE Setting range : L/H, G/H.
Default value : L/H.

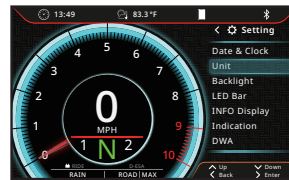

- The unit screen.

5-3 Backlight(Mode/Brightness) Setting

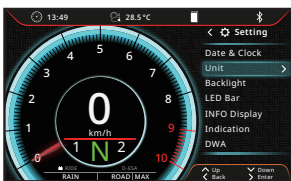

- The backlight screen, press the **Right button** to enter the background mode setting.

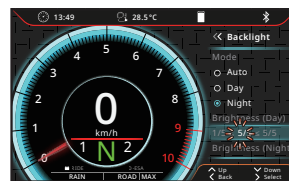

- Example** : To set the backlight brightness (Day) to 4/5(80%).
- Press the **Up or Down button** to choose the setting number.
- Press the **Right button** to confirm the selection.

⚠ Now the setting value is flashing!

NOTE Setting range : 1/5(Darkest)~5/5(Brightest).
Setting unit : 20% per level.
Default value : 5/5(100%).



- Example** : To set the Mode to Night mode.
- Press the **Up or Down button** to choose the setting options.
- Press the **Right button** to confirm the selection.

NOTE Setting Auto(automatically switch according to the light : day mode display for a bright environment and Night mode display for a dark environment), Day mode, Night mode.
Default value : Auto.

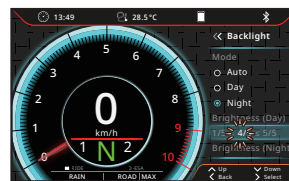

- EX : The backlight brightness (Day) setting is changed from 5/5 (100%) to 4/5 (80%).
- Press the **Down button** to go to the backlight brightness (Night) setting.



- EX : Set background from Auto mode to Night mode.
- Press the **Down button** to go to the backlight brightness (Day) setting.

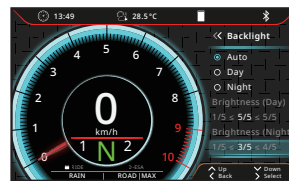

- Press the **Right button** to enter the backlight brightness (Night) setting.



- Press the **Right button** to enter the backlight brightness (Day) setting.

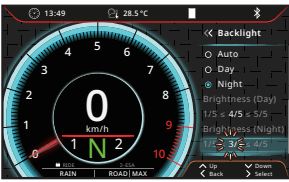

- **Example** : To set the backlight brightness (Night) to 2/5(40%).
- Press the **Up** or **Down** button to choose the setting number.
- Press the **Right** button to confirm the selection.

⚠ Now the setting value is flashing!

NOTE Setting range : 1/5(Darkest)~5/5(Brightest), shall be \leq the setting value of the backlight luminance (Day).
Setting unit : 20% per level.
Default value : 3/5(60%).

NOTE The backlight brightness will change immediately after you set the value.

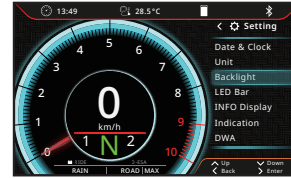

- The backlight screen.

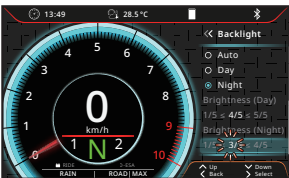

- **EX** : The backlight brightness (Night) setting is changed from 3/5 (60%) to 2/5 (40%).
- Press the **Left** button to go back to the backlight screen.

5-4 LED Bar (Brightness) Setting

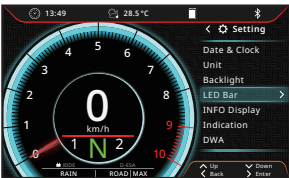

- The LED Bar screen, press the **Right** button to enter the LED Bar brightness (Day) setting.



- Press the **Right** button to enter the LED Bar brightness (Night) setting.



- Press the **Right** button to enter the LED Bar brightness (Day) setting.

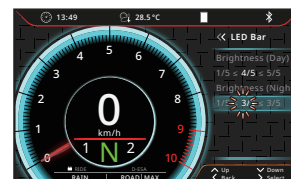

- **Example** : To set the LED Bar brightness (Night) to 2/5(40%).
- Press the **Up** or **Down** button to choose the setting number.
- Press the **Right** button to confirm the selection.

⚠ Now the setting value is flashing!

NOTE Setting range : 1/5(Darkest)~5/5(Brightest), shall be \leq the setting value of the LED bar luminance (Day).
Setting unit : 20% per level.
Default value : 3/5(60%).

NOTE The LED Bar brightness will change immediately after you set the value.



- **Example** : To set the LED Bar brightness (Day) to 4/5(80%).
- Press the **Up** or **Down** button to choose the setting number.
- Press the **Right** button to confirm the selection.

⚠ Now the setting value is flashing.

NOTE Setting range : 1/5(Darkest)~5/5(Brightest).
Setting unit : 20% per level.
Default value : 5/5(100%).

NOTE The LED Bar brightness will change immediately after you set the value.

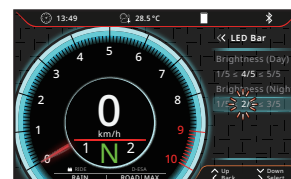

- **EX** : The LED Bar brightness (Night) setting is changed from 3/5 (60%) to 2/5 (40%).

- Press the **Left** button to go back to the LED Bar screen.



- **EX** : The LED Bar brightness (Day) setting is changed from 5/5 (100%) to 4/5 (80%).
- Press the **Down** button to go to the LED Bar brightness (Night) setting.

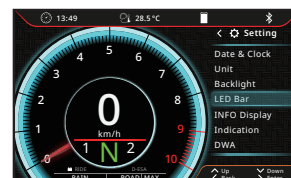

- The LED Bar screen.

5-5 INFO Display Setting

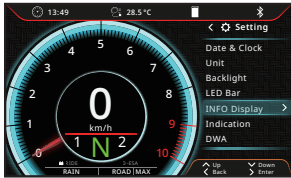

- The INFO Display screen, press the **Right button** to enter the INFO Display setting.

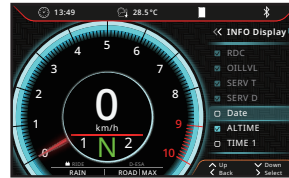

- EX : Set Date display from show to hidden.
- Press the **Left button** to go back to the INFO Display screen.

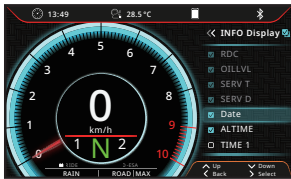

- Example : To hide Date display.
- Press the **Up or Down button** to choose the setting options.
- Press the **Right button** to choose whether to show or hidden the info.

NOTE Items in grey color may not be adjusted.

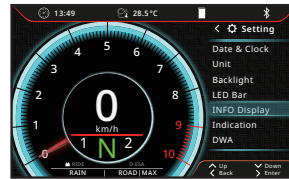

- The INFO Display screen.

5-6 Indication Setting

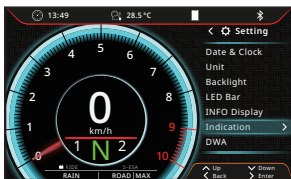

- The indication screen, press the **Right button** to enter the Indication setting.

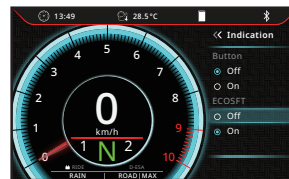

- Example : To set the **ECOSFT indication function to off.**
- Press the **Up or Down button** to choose the setting options.
- Press the **Right button** to confirm the selection.

- The ECOSFT indication function screen.



NOTE Setting range : on, off.
Default value : on.

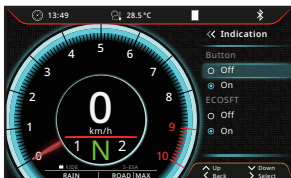

- Example : To set the **Button indication function to off.**
- Press the **Up or Down button** to choose the setting options.
- Press the **Right button** to confirm the selection.

NOTE Setting range : on, off.
Default value : on.

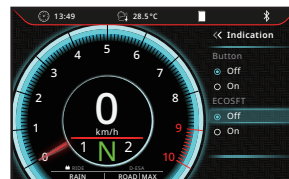

- EX : Set ECOSFT indication function from on to off.
- Press the **Left button** to go back to the indication screen

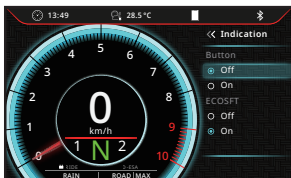

- EX : Set Button Indication function from on to off.
- Press the **Down button** to go to the ECOSFT indication function setting screen.

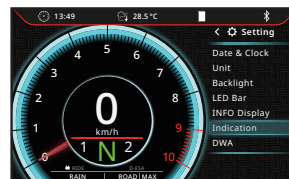

- The indication screen.

5-7 DWA Setting



- The DWA screen, press the **Right button** to enter the DWA setting.



- EX : Set DWA function from on to off.
- Press the **Left button** to go back to the DWA screen



- Example : To set the **DWA function to off.**
- Press the **Up or Down button** to choose the setting options.
- Press the **Right button** to confirm the selection.

NOTE Setting range : on, off.
Default value : on.

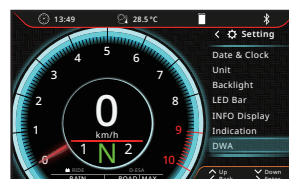

- The DWA screen.

5-8 Shift Light Setting

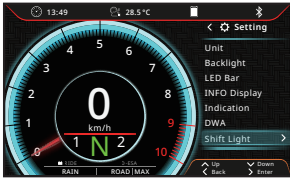

- The Shift Light screen, press the **Right button** to enter the Shift Light setting.

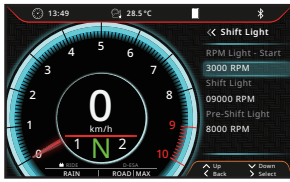

- Press the **Right button** to enter the RPM Light - Start setting.

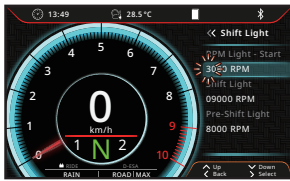

- **Example : To set the RPM Light - Start value to 5,000 RPM.**
- Press the **Up or Down button** to choose the setting value.
- Press the **Right button** to confirm the selection.

⚠ Now the setting value is flashing!

NOTE Setting range : 1,000~8,000 RPM.
Setting unit : 100 RPM.
Default value : 3,000 RPM.

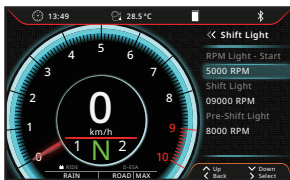

- **EX :** Set RPM Light - Start value from 3,000 RPM to 5,000 RPM.
- Press the **Down button** to go to the Shift Light setting.

- Status of the LED bar when the RPM reaches the starting value.

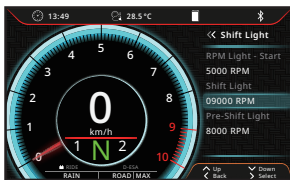

- Press the **Right button** to enter the Shift Light setting.



- **Example : To set the Shift Light value to 10,000 RPM.**
- Press the **Up or Down button** to choose the setting value.
- Press the **Right button** to confirm the selection.

⚠ Now the setting value is flashing!

NOTE Setting range : 2,000~10,000 RPM.
Setting unit : 100 RPM.
Default value : 9,000 RPM.

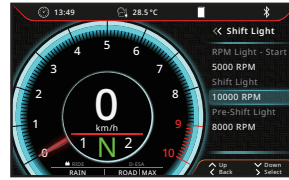

- **EX :** Set Shift Light value from 9,000 RPM to 10,000 RPM.
- Press the **Down button** to go to the Pre-Shift Light setting.

- Status of the LED bar and the screen when the RPM reaches the excessive rotation value

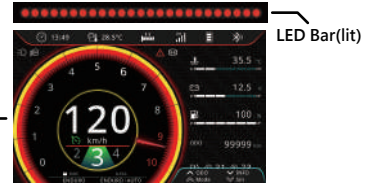

The ring for the RPM turns red

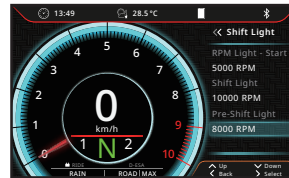

- Press the **Right button** to enter the Pre-Shift Light setting.

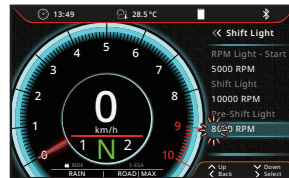

- **Example : To set the Pre-Shift Light value to 9,000 RPM.**
- Press the **Up or Down button** to choose the setting value.
- Press the **Right button** to confirm the selection.

⚠ Now the setting value is flashing!

NOTE Setting range : 1,000~10,000 RPM.
Setting unit : 100 RPM.
Default value : 8,000 RPM.

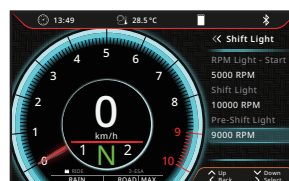

- **EX :** Set Pre-Shift Light value from 8,000 RPM to 9,000 RPM.
- Press the **Left button** to go back to the Shift Light screen.

- Status of the LED bar when the RPM reaches the Pre-Shift Light value.

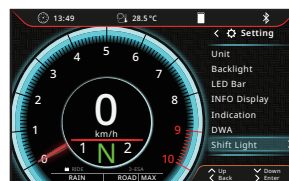

- The Shift Light screen.

5-9 Low Fuel Alert Setting

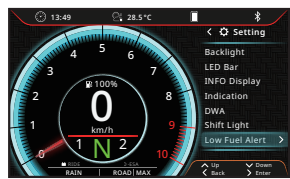

- The Low Fuel Alert screen, press the **Right button** to enter the Low Fuel Alert setting.



- **Example : To set the Low Fuel Alert value to 20%.**
- Press the **Up or Down button** to choose the setting value.
- Press the **Right button** to confirm the selection.

NOTE Setting range : 10~50%.
Default value : 30%.

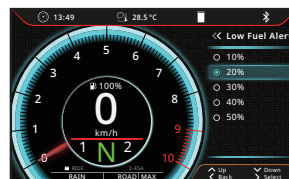

- **EX :** Set Low Fuel Alert value from 30% to 20%.
- Press the **Left button** to go back to the Low Fuel Alert screen.

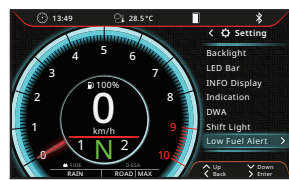

- The Low Fuel Alert screen.

5-10 ENG TMP Alert Setting

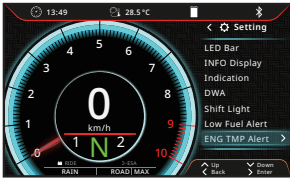

- The ENG TMP Alert screen, press the **Right button** to enter the ENG TMP Alert setting.

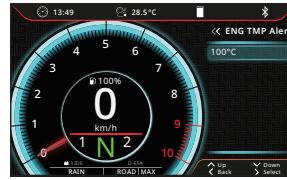

- EX : Set ENG TMP Alert value from 90 °C to 100 °C.
- Press the **Left button** to go back to the ENG TMP Alert screen.

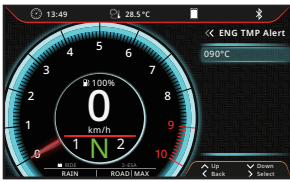

- Press the **Right button** to enter the ENG TMP Alert setting.

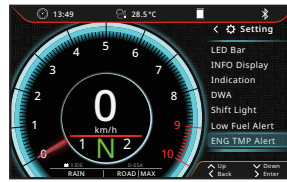

- The ENG TMP Alert screen.

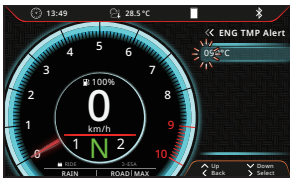

- Example : To set the ENG TMP Alert value to 100 °C.**
- Press the **Up or Down button** to choose the setting value.
- Press the **Right button** to confirm the selection.

NOTE Setting range : 60~250 °C
(140~482°F).
Default value : 90 °C (194°F).

5-11 Volt WARN Setting

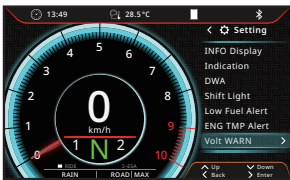

- The Volt WARN screen, press the **Right button** to enter the Volt WARN setting.

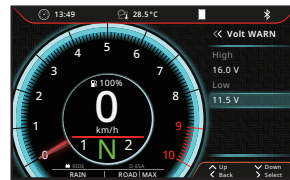

- Press the **Right button** to enter the Low Volt WARN setting.

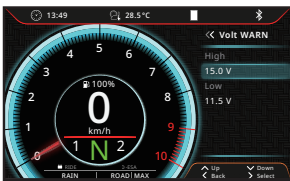

- Press the **Right button** to enter the High Volt WARN setting.

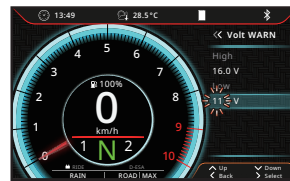

- Example : To set the Low Volt WARN value to 11.0 V.**
- Press the **Up or Down button** to choose the setting value.
- Press the **Right button** to confirm the selection.

NOTE Setting range : DC 8.0~13.0 V.
Default value : 11.5 V.

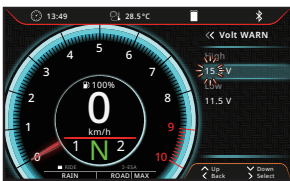

- Example : To set the High Volt WARN value to 16.0 V.**
- Press the **Up or Down button** to choose the setting value.
- Press the **Right button** to confirm the selection.

NOTE Setting range : DC 13.1~18.0 V.
Default value : 15.0 V.

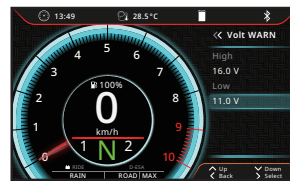

- EX : Set Low Volt WARN value from 11.5 V to 11.0 V.
- Press the **Left button** to go back to the Volt WARN screen.



- EX : Set High Volt WARN value from 15.0 V to 16.0 V.
- Press the **Down button** to go to the Low Volt WARN setting.

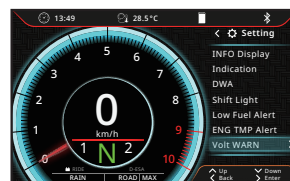

- The Volt WARN screen.

5-12 Internal and External ODO Setting

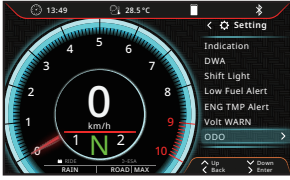

- The internal and external ODO screen, press the **Right button** to enter the internal and external ODO setting.

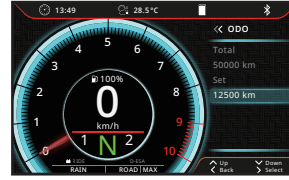

- EX : Set external total distance value from 10,000 km to 12,500 km.
- Press the **Left button** to go back to the internal and external ODO screen.

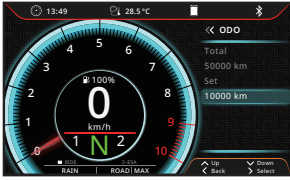

- Press the **Right button** to enter the internal and external ODO setting.

⚠ User unable to adjust or clear internal ODO.

NOTE Display range : 0~99,999 km (mile).

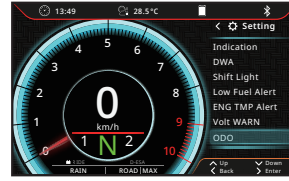

- The internal and external ODO screen.

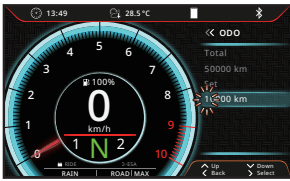

- **Example** : To set external total distance value to **12,500 km**.
- Press the **Up or Down button** to choose the setting value.
- Press the **Right button** to confirm the selection.

⚠ Now the setting value is flashing!

Cursor's order : ten thousands→thousand→hundred→ten→digit.

NOTE Setting range : 0 ~ 99,999 km (mile).

NOTE When connecting to the meter for the first time, the total external mileage displays the ODO record value.

5-13 Maintenance Setting

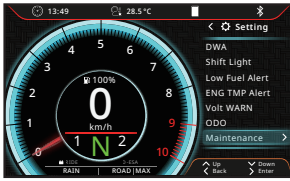

- The Maintenance screen, press the **Right button** to enter the Maintenance setting.

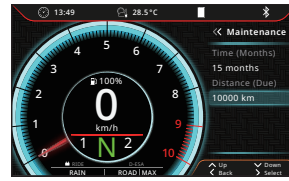

- Press the **Right button** to enter the Maintenance(Distance) setting.

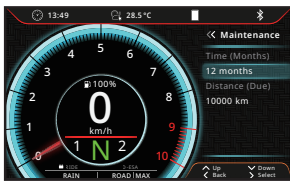

- Press the **Right button** to enter the Maintenance(Time) setting.

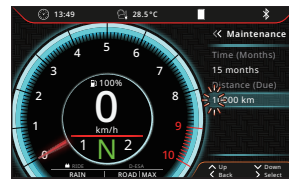

- **Example** : To set the Maintenance (Distance) value to **12,000 km**.
- Press the **Up or Down button** to choose the setting value.
- Press the **Right button** to confirm the selection.

⚠ Now the setting value is flashing!

NOTE Setting range : 0~16,000 km (mile).
Default value : 10,000 km (mile).

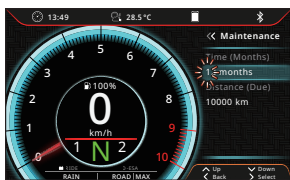

- **Example** : To set the Maintenance (Time) to **8 months**.
- Press the **Up or Down button** to choose the setting value.
- Press the **Right button** to confirm the selection.

⚠ Now the setting value is flashing!

NOTE Setting range : 1~24 month.
Default value : 12 months.

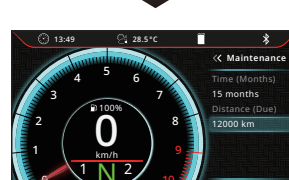

- EX : Set Maintenance(Distance) from 10,000 km to 12,000 km.
- Press the **Left button** to go back to the Maintenance screen.



- EX : Set Maintenance(Time) from 12 months to 15 months.
- Press the **Down button** to go to the Maintenance(Distance) setting.

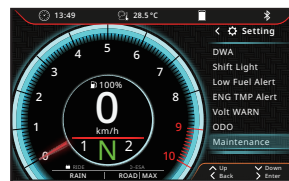

- The Maintenance screen.

5-14 Meter information Setting

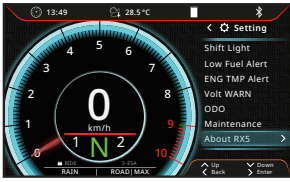

- The meter information screen, press the **Right button** to enter the meter information setting.

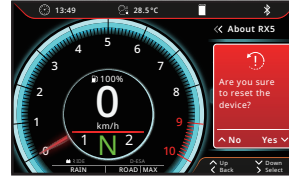

- Press the **Down button** to confirm reset.
- Press the **Up button** to cancel reset.

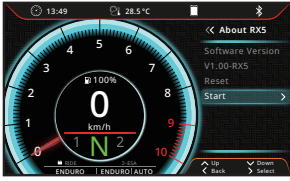

- **Example** : To reset the meter(original setting).
- Press the **Right button** to reset.
- **NOTE** User unable to adjust or clear software Version.

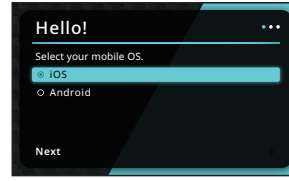

- Successfully reset and return to the boot screen for initial use.

5-15 Bluetooth® Setting

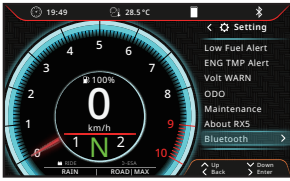

- The Bluetooth® screen, press the **Right button** to enter the Bluetooth® setting.

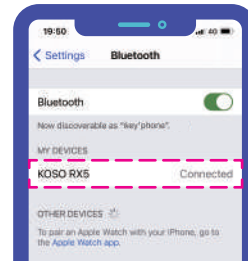

- Device successfully connected.

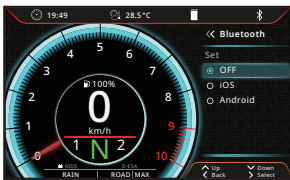

- **Example** : To set mobile operating system to iOS.
- Press the **Up or Down button** to choose the setting options.

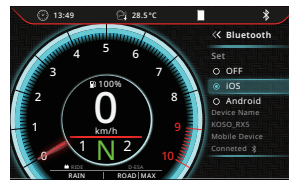

- **EX** : Bluetooth® successfully connected.
- Press the **Left button** to go back to the Bluetooth screen.

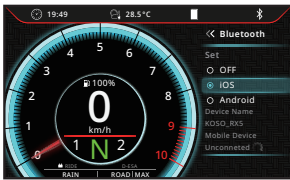

- **EX** : Set mobile operating system from OFF to iOS.

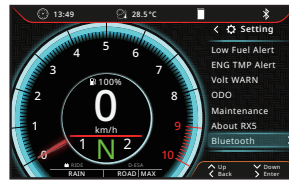

- The Bluetooth® screen.
- **NOTE** After successfully connecting to the Bluetooth®, the main screen will be able to display navigation, internet signal of the phone, battery of the phone, historical call records, incoming call notice, incoming online call notice, music playing information, and push notifications.

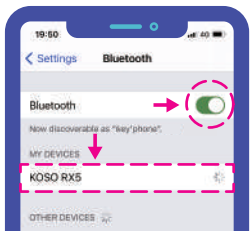

- Turn on the Bluetooth® function of the mobile phone.
- Press device "KOSO RX5."



- Enter the code displayed on "KOSO RX5."

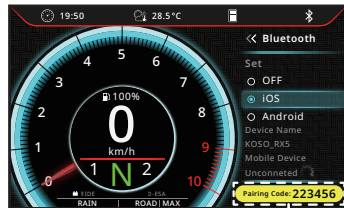

Phone battery / Network signal

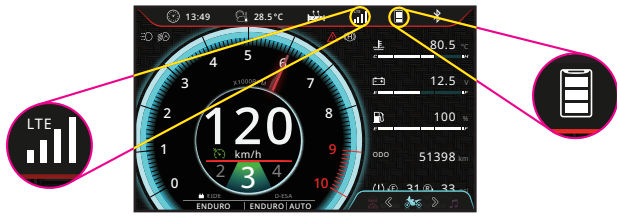

●Phone battery / Network signal.

NOTE Phone battery : 1~33%, 2~3bars (2bars=34~66%, 3bars=67%~100%)

NOTE Network signal : 1~4bars.
→Android supported, iOS not supported.

Push notification



●Push notification screen.

NOTE Display range :
Name-One line; no display when exceeding the range
Content-One line; no display when exceeding the range
→iOS supported, Android not supported.

Incoming phone call notice / Incoming online app call notice

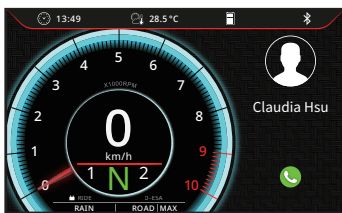

●Incoming phone call notice screen.
●Incoming online call notice screen.

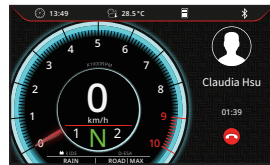
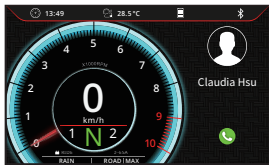

●Call ending screen.

NOTE Incoming phone call notification : name or number ; "No Caller ID" is displayed when there is no name or number.

Incoming online app call notification : name ; "No Caller ID" is displayed when there is no name.

For online calls of the Android system, whether the calls get through or not, the display will disappear after 10 seconds.

→supported : LINE, Messenger, WeChat, Whats App

Call time : 00:00~59:59, "59:59+" will be displayed when exceeding the range.

Call History

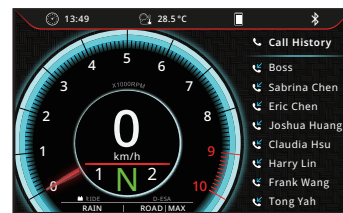

●Call History screen.

NOTE Call History : Record eight incoming calls received after connecting with the mobile.

Music playing info

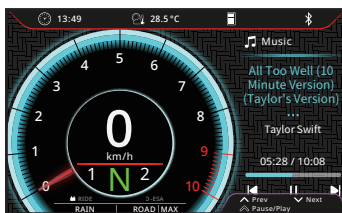

●Music playing screen.
●Press the **Up** button to go back to the previous song.
●Press the **Down** button to go to the next song.
●Press the **Up** button for 3 seconds, Play / Stop music.
●Press the **Left** or **right** button to adjust the volume.

NOTE Song title : Three lines; "... " will be displayed when exceeding the range.

Artist name: One line; no display when exceeding the range.

Total length of the song : 00:00~59:59, "59:59+" will be displayed when exceeding the range

→iOS supported, Android not supported.

Current playing time : 00:00 ~ 59:59 "59:59+" will be displayed when exceeding the range

→iOS supported, Android not supported.

Current playing time progress bar : Bar displays from 0 to 100%. (current playing time/total time length of the music)

→iOS supported, Android not supported.

Previous song : iOS supported, Android not supported.

Next song : iOS supported, Android not supported.

Play / Stop : iOS supported, Android not supported.

Volume +/- : 0~100%, iOS supported, Android not supported.

Navigation

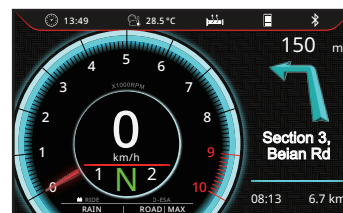

●Navigation screen of the meter.

NOTE Turning precaution : A total of 40 turning precautions.
Estimated turning distance : 0~999m, 1~999km (0~528ft, 0.1~999.9mile).
Estimated turning road : Three lines; "... " will be displayed when exceeding the range.
Estimated arrival time : 00:00 ~ 23:59 (24H), 1:00 ~ 12:59 (12H).
Estimated arriving distance : 0~999m, 1~999km (0~528ft, 0.1~999.9mile).
→(Android supported, iOS not supported.)

Bluetooth® disconnection

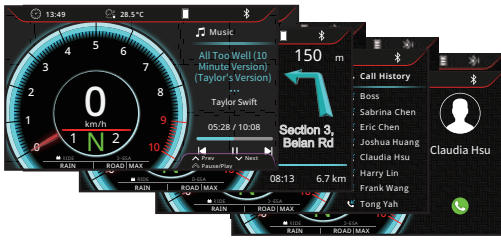

The screen will return to the main screen when the Bluetooth is disconnected.

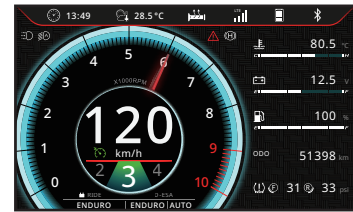

NOTE The screen will return to the main screen when the Bluetooth is disconnected on the music, navigation, historical call record, or incoming call notification screen.

※ “The Company is committed to optimizing the Bluetooth® application function of the meter. However, as support for software and hardware are different as mobile phones differ, the Bluetooth® application function of the meter may be affected, causing differences in functions.”

6 Trouble Shooting

The following situations do not necessarily indicate malfunction of the product. Check the following points, before contacting us.

Trouble	Check item	Trouble	Check item
The meter doesn't work when the power is on.	<ul style="list-style-type: none"> ●Power isn't supplied to the meter. →Make sure the wiring is connected. The wiring and fuse are not broken. →The battery is too old to supply needed power (DC 12 V). 	Fuel meter doesn't display or displays error.	<ul style="list-style-type: none"> ●Maybe the fuel tank is empty. →Check your fuel tank.
The meter shows wrong information.	<ul style="list-style-type: none"> ●Check the voltage of your battery, and make sure the voltage is over DC 12 V. 	The clock is incorrect.	<ul style="list-style-type: none"> ●Check the setting. →Check the settings menu, the clock settings are correct.
Speed doesn't appear or appears incorrectly.	<ul style="list-style-type: none"> ●May be due to poor connection of wiring. →Check whether the wires are disconnected or have fallen off. 	Voltage doesn't appear or appears incorrectly.	<ul style="list-style-type: none"> ●May be due to poor connection of wiring. →Check whether the wires are disconnected or have fallen off.
Tachometer doesn't appear or appears incorrectly.	<ul style="list-style-type: none"> ●May be due to poor connection of wiring. →Check whether the wires are disconnected or have fallen off. 	The meter indicator didn't display.	<ul style="list-style-type: none"> ●May be due to poor connection of wiring. →Check whether the wires are disconnected or have fallen off.
Temperature doesn't appear or appears incorrectly.	<ul style="list-style-type: none"> ●May be due to poor connection of wiring. →Check whether the wires are disconnected or have fallen off. 		

※ If the problems still can't be solved, contact our technical department for assistance.

Android™ is a registered trademark of Google LLC. Apple® and iPhone® is a trademarks of Apple Inc., registered in the U.S. and other countries. The Bluetooth® word mark and logos are registered trademarks owned by Bluetooth SIG, Inc. and any use of such marks by Tong Yah Electronic Technology Co.,Ltd is under license. Other trademarks and trade names are those of their respective owners.