



Thank you for purchasing our product. Before installing/operating the product, please read the instructions carefully and retain them for future reference.

## ⚠ Attention!

- For installation, please follow the steps described. Any damage caused by wrong installation shall be imputed to the users.
- To avoid a short circuit from occurring do not pull or modify the wires during installation.
- Do not disassemble or change any parts. Opening and disassembling this unit will void any warranty.
- Maintenance and repairs should be executed by our professionals only.

Symbol description:

### NOTE

⚠ Some procedures must be followed to avoid damages to the instrument.

⚠ **WARNING!** Certain procedures must be followed to avoid damages to yourself, to the vehicle or others.

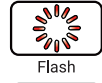

## 1-1 Accessories

### 1 LCD Meter X1

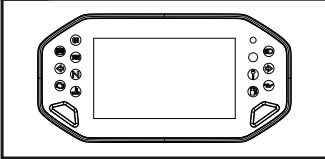

## 2-1 Installation instructions

Figure 1

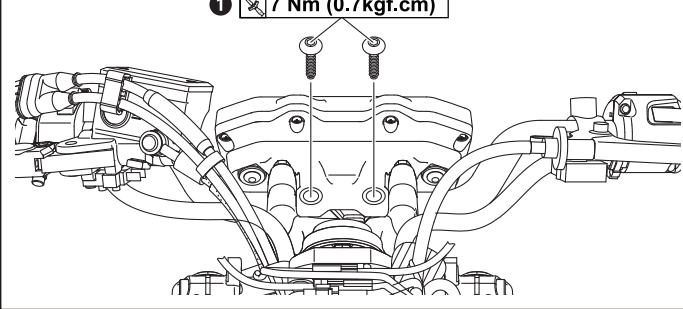

Figure 2

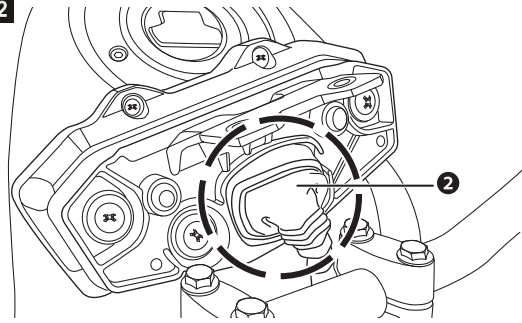
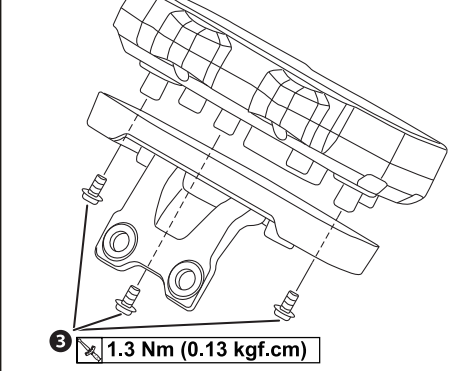

Figure 3



### Follow the steps below during installation.

- 1 M6 Head Hexagon Socket Screw X2  $7 \text{ Nm (0.7 kgf.cm)}$
- 2 The original main wiring harness
- 3 M5 Head Hexagon Socket Screw X3  $1.3 \text{ Nm (0.13 kgf.cm)}$

**NOTE** Refer to the sequence of the graph for the removal. Perform the assembly in a sequence reverse to the removal.

## 2-2 Wiring Installation Instructions

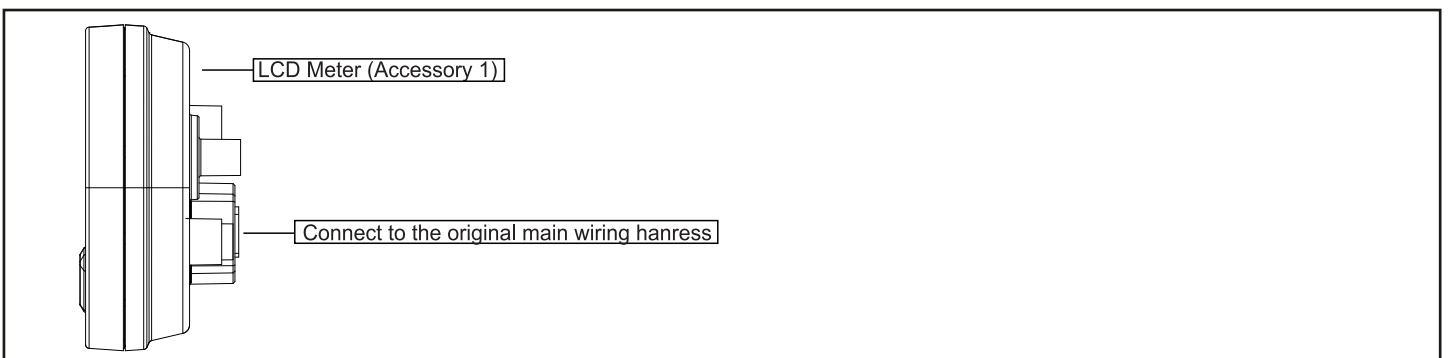

### 3-1 Corresponding No. of the Vehicle

Model	Meter part No.	Model	Meter part No.	Model	Meter part No.	Model	Meter part No.
MT-07	1WS-83500-00	MT-09	1RC-83500-00	XSR700	B2G-83500-00	XSR900	B90-83500-00
	1WS-83500-10		1RC-83500-10		B2G-83500-10		B90-83500-10
	2RC-83500-00		1RC-83500-20		B2G-83500-20		B90-83500-20
	2RC-83500-10		1RC-83500-30		B2G-83500-30		B90-83500-30
	2RC-83500-20		1RC-83500-40		B34-83500-00		B90-83500-40
	2RC-83500-30		1RC-83500-50		B34-83500-10		B90-83500-50
	1XB-83500-00		2DR-83500-00		B90-83500-60		
	1XB-83500-10		2DR-83500-10		B90-83500-70		
	BC6-83500-00						
	BC6-83500-10						

According to the table above, the vehicle type is "MT-07," and the meter part No. is "2RC-83500-30."

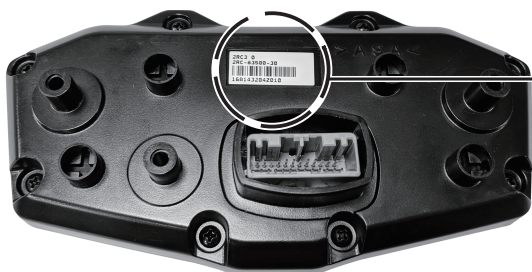

**NOTE** The "meter part No." may be found on the label attached to the back of the original meter or the original part manual.

### 3-2 Meter Size

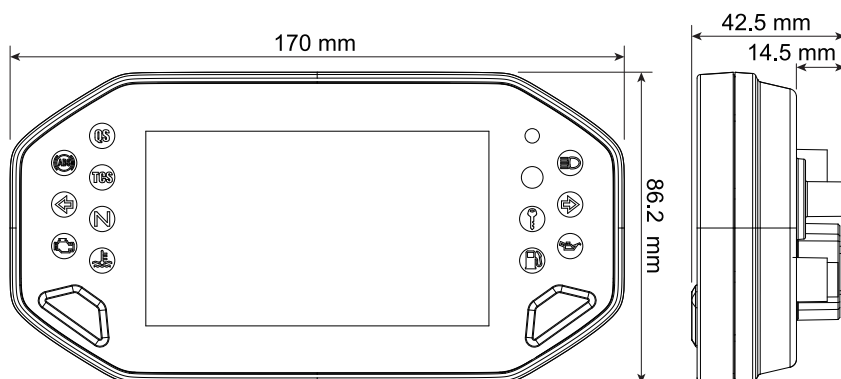

### 3-3 Basic Function Instructions

**Tachometer**

- Display range :  
MT-07 : 0 ~ 12,000 RPM  
MT-09 : 0 ~ 13,000 RPM  
XSR700 : 0 ~ 12,000 RPM  
XSR900 : 0 ~ 13,000 RPM

**Clock**

- Display range :  
00:00 ~ 23:59 (24H),  
1:00 ~ 12:59 (12H)

**ECO Indicator**

- Display range : display, No display

**Phone battery**

- Display range : 3 segments.

**Bluetooth® connection status**

- Display range :  
Steady (connected),  
OFF (Unconnected)

**Fuel meter**

- Display range : 6 levels

**Fuel warning**

- Display unit : 1 level (16.6 %)
- Display range : The warning value for low fuel shall be 1 segment and below, the warning signal will blink.

**Indicator**

- ABS light (Amber)
- Left indicator light (Green)
- Engine light (Amber)
- QS Quick switch signal (Green)
- TCS Traction control signal (Amber)
- Neutral light (Green)
- Coolant temperature warning light (Red)
- RPM shift light (Red)
- IMMO anti-theft light (Red)
- Low fuel warning light (Amber)
- High beam light (Blue)
- Right indicator light (Green)
- Motor oil light (Red)

**Gear Meter**

- Display range :  
-, N, 1 ~ 6

**Speedometer**

- Display range :  
0 ~ 360 km/h (0 ~ 225 MPH)
- Display unit :  
1 km/h (MPH) Switchable

**TCS display**

- Display range : 1, 2, OFF

**Driving mode**

- Display range : STD, A, B

**Voltmeter**

- Display range : DC 8.0 ~ 18.0 V
- Display unit : DC 0.1 V

**Time Trip**

- Display range : 0 ~ 999.9 H
- Display unit : 0.1 hr

**Time 1, 2**

- Display range : 0 ~ 999.9 H
- Display unit : 0.1 hr

**Coolant temperature warning**

- Display range : 0 ~ 250 °C (32 ~ 482 °F)
- Display unit : 1 °C (°F)

**Current fuel consumption**

- Display range : 0 ~ 40.0 km/L, 2.5 ~ 99.9 L/100km, 0 ~ 99.9 MPG(US), 0 ~ 99.9 MPG(UK)
- Display unit : 0.1 km/L, 0.1 L/100km, 0.1 MPG(US), 0.1 MPG(UK)











**Average fuel consumption**

- Display range : 0 ~ 40.0 km/L, 2.5 ~ 99.9 L/100km, 0 ~ 99.9 MPG(US), 0 ~ 99.9 MPG(UK)
- Setting unit : 0.1 km/L, 0.1 L/100km, 0.1 MPG(US), 0.1 MPG(UK)

**Trip meter 1, 2**

- Display range : 0.0 ~ 9,999.9 km (mile), may return to zero manually
- Setting unit : 0.1 km (mile)

## 3-4 Specifications

●Speedometer	Display range : 0 ~ 360 km/h (0 ~ 225 MPH) Display unit : 1 km/h (MPH) Switchable	●Voltmeter	Display range : DC 8.0 ~ 18.0 V Display unit : DC 0.1 V
●Odometer	Display range : 0 ~ 999,999 km (mile) Display unit : 1 km (mile)	○Low voltage warning	Setting range : DC 8.0~13.0 V, LO means the setting value and below; the numbers will turn red and blink as a warning. Setting unit : DC 0.1 V
●Trip meter 1, 2	Display range : 0,0~9,999.9 km (mile) , may return to zero manually. Setting unit : 0.1 km (mile)	○High voltage warning	Setting range : DC 13.1~18.0 V, HI means the setting value or above; the numbers will turn red and blink as a warning. Setting unit : DC 0.1 V
●Low fuel mileage	Display range : 0 ~ 999 km (mile) Display unit : 1 km (mile)	●Target speed	Setting range : 0 ~ 360 km/h (0 ~ 225 MPH)
●Motor oil maintenance	Setting range : User settings(500 ~ 16,000 km/300 ~ 10,000 mile) ~ -999 km (mile) . Automatically decrease. Display unit : 1 km (mile) Warning range : Texts will turn red as a warning for 0 km (mile) and below.	●Target distance	Setting range : 50 ~ 1,500 m (1/32 ~ 30/32 mile)
○Maintenance mileage 1, 2	Setting range : User settings(500 ~ 16,000 km/300 ~ 10,000 mile) ~ -999 km (mile) . Automatically decrease. Display unit : 1 km (mile) Warning range : Text will turn red as a warning for 0 km (mile) and below.	●Top speed	Display range Speed : 0 ~ 360 km/h (0 ~ 225 MPH) Distance : 0 ~ 999 m (0~3,280 feet) RPM speed : 0 ~ The setting value of the rpm at top speed Time : 0 ~9 : 59'99
●Max. speed record	Display range : 0 ~ 360 km/h (0 ~ 225 MPH)	●Bluetooth® connection status	Operating system iOS : iOS 5.0 and above Android : Android 9 and above
●Gear Meter	Display range : -, N, 1 ~ 6	●Phone battery	Display range: 3 segments
○Max. gear record	Display range : -, N, 1 ~ 6	●Incoming phone call notice	Display range: Display name or number for up to 12 letters; "... " is displayed for more than 12 letters; "Unknown" is displayed when there is no name iOS - Display either name or number of the incoming call Android - Display number only
●Tachometer	Display range:[MT-07] : 0 ~ 12,000 RPM [MT-09] : 0 ~ 13,000 RPM [XSR700] : 0 ~ 12,000 RPM [XSR900] : 0 ~ 13,000 RPM	●Incoming online app call notice	Display range: Display name for up to 12 letters; "... " is displayed for more than 12 letters; "Unknown" is displayed when there is no name App supported: LINE, WeChat, WhatsApp iOS supported, Android not supported.
○Shift light warning	Display range : Steady, Flash and Segment flashing warning Setting range:[MT-07] : 1,000 ~ 12,000 RPM [MT-09] : 1,000 ~ 13,000 RPM [XSR700] : 1,000 ~ 12,000 RPM [XSR900] : 1,000 ~ 13,000 RPM Setting unit: 500 RPM (Small grid) 1,000 RPM (Large grid)	●Music playing message	Song name : 15 letters, and "... " is displayed when > 15 letters Artist name : 18 letters, and "... " is displayed when > 18 letters Total length of the music : 00:00 ~ 9:59:59 (iOS supported, Android not supported). Current playing time : 00:00 ~ 9:59:59 (iOS supported, Android not supported).
○Max. RPM speed	Display range: [MT-07] : 0 ~ 12,000 RPM [MT-09] : 0 ~ 13,000 RPM [XSR700] : 0 ~ 12,000 RPM [XSR900] : 0 ~ 13,000 RPM	●Push notification	Display range: Name - 4 letters, "... " is displayed when > 4 letters Content -17 letters, "... " is displayed when > 17 letters Support iOS, not Android.
●Air temperature	Display range : -10 ~ 100 °C (14 ~ 212 °F) Display unit : 1 °C (°F) Warning range : LO means below -10 °C (14 °F); HI means higher than 100 °C (212 °F); the numbers will turn red and blink for warning.	●Driving mode	Display range: STD \ A \ B
○Coolant temperature	Display range : 0 ~ 250 °C (32 ~ 482 °F) Display unit : 1 °C (°F)	●TCS display	Display range: 1, 2, OFF
○Max. coolant temperature record	Display range : 0 ~ 250 °C (32 ~ 482 °F)	●ECO Indicator	Display range: display, No display
○Coolant temperature warning	Display range : LO means below 39 °C (102 °F); HI means higher than 117 °C (234 °F); the numbers will turn red and blink for warning. Unit: Celsius (°C) or Fahrenheit (°F)	●Back light color	Setting range : blue, green, orange, white
●Fuel meter	Display range : 6 segments Display unit : 1 segment (16.6 %)	●Voltage	DC 12 V
○Fuel warning setting	Display range : The warning value for low fuel shall be 1 segment and below, the symbol will blink for warning.	●Operating temperature	-20~ 85 °C
○Current fuel consumption	Display range : 0 ~ 40.0 km/L, 2.5 ~ 99.9 L/100km, 0 ~ 99.9 MPG(US), 0 ~ 99.9 MPG(UK) Display unit : 0.1 km/L, 0.1 L/100km, 0.1 MPG(US), 0.1 MPG(UK)	○Storage temperature	-30~ 90 °C
○Average fuel consumption	Display range : 0 ~ 40.0 km/L, 2.5 ~ 99.9 L/100km, 0 ~ 99.9 MPG(US), 0 ~ 99.9 MPG(UK) Display unit : 0.1 km/L, 0.1 L/100km, 0.1 MPG(US), 0.1 MPG(UK)	●Specification	JIS D 0203 (S2)
●Clock	Setting range : 00:00 ~ 23:59 (24H), 1:00 ~ 12:59 (12H)	●Meter Size	170 x 86.2 x 42.5 mm
○Time Trip	Display range : 0 ~ 999.9hr Display unit : 0.1 hr	●Meter Weight	Around 244.0 g
○Time 1,2 (cumulative time)	Display range : 0 ~ 999.9hr Display unit : 0.1 hr	●Indicator	ABS light (Amber)  Left indicator light(Green)  Check engine light (Amber)  QS Quick switch signal (Green)  TCS Traction control signal (Amber)  Neutral light (Green)  Coolant temperature warning light(Red)  RPM shift light (Red)  IMMO anti-theft light(Red)  Low fuel warning light (Amber)  High beam light (Blue)  Right indicator light(Green)  Motor oil maintenance light (Red) 
<b>NOTE</b> Design and specifications are subject to change without notice!			

### 3-5 Vehicle Series Function Comparison Table

Model	Original meter part No.	Indicator function			Default value				
		TCS	ABS	QS	Speed unit	Temperature unit	Fuel consumption unit	Shift light warning (Steady)	Shift light warning (Flash)
MT07	1WS-83500-00	X	X	X	km/h	°C	km/L	8000	10000
	1WS-83500-10	X	X	X	mph	°F	MPG(UK)	8000	10000
	2RC-83500-00	X	X	X	mph	°F	MPG(US)	8000	10000
	2RC-83500-10	X	X	X	km/h	°C	km/L	8000	10000
	2RC-83500-20	X	V	X	mph	°F	MPG(US)	8000	10000
	2RC-83500-30	X	V	X	km/h	°C	km/L	8000	10000
	1XB-83500-00	X	V	X	km/h	°C	km/L	8000	10000
	1XB-83500-10	X	V	X	mph	°F	MPG(UK)	8000	10000
	BC6-83500-00	X	V	X	km/h	°C	km/L	8000	10000
	BC6-83500-10	X	V	X	mph	°F	MPG(UK)	8000	10000
MT09	1RC-83500-00	X	X	X	km/h	°C	km/L	9250	11250
	1RC-83500-10	X	X	X	mph	°F	MPG(UK)	9250	11250
	1RC-83500-20	X	X	X	mph	°F	MPG(US)	9250	11250
	1RC-83500-30	X	V	X	km/h	°C	km/L	9250	11250
	1RC-83500-40	X	V	X	mph	°F	MPG(UK)	9250	11250
	1RC-83500-50	X	X	X	km/h	°C	km/L	9250	11250
	2DR-83500-00	V	V	X	km/h	°C	km/L	9250	11250
	2DR-83500-10	V	V	X	mph	°F	MPG(UK)	9250	11250
XSR700	B2G-83500-00	X	V	X	mph	°F	MPG(US)	8000	10000
	B2G-83500-10	X	V	X	km/h	°C	km/L	8000	10000
	B2G-83500-20	X	V	X	km/h	°C	km/L	8000	10000
	B2G-83500-30	X	V	X	mph	°F	MPG(UK)	8000	10000
	B34-83500-00	X	V	X	km/h	°C	km/L	8000	10000
	B34-83500-10	X	V	X	mph	°F	MPG(UK)	8000	10000
XSR900	B90-83500-00	V	V	X	km/h	°C	km/L	9250	11250
	B90-83500-10	V	V	X	mph	°F	MPG(UK)	9250	11250
	B90-83500-20	V	V	X	mph	°F	MPG(US)	9250	11250
	B90-83500-30	V	V	X	km/h	°C	km/L	9250	11250
	B90-83500-40	V	V	X	km/h	°C	km/L	9250	11250
	B90-83500-50	V	V	X	mph	°F	MPG(UK)	9250	11250
	B90-83500-60	V	V	X	mph	°F	MPG(US)	9250	11250
	B90-83500-70	V	V	X	km/h	°C	km/L	9250	11250



## 4-1 Start screen for Initial Use

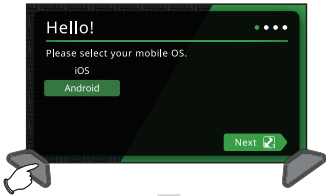

- Start screen for Initial Use, press the **Adjust or Select** button to choose mobile operating system.

**NOTE** Press the left button for explanation in the graphics.

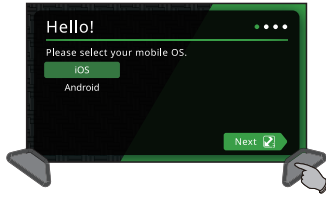

- Press the **Adjust** button for 3 seconds, enter the Bluetooth® pairing screen.
- EX : Select iOS for mobile phone operating system

**NOTE** iOS operating system:  
iOS 5.0 and above  
Android operating system:  
Android 9 and above

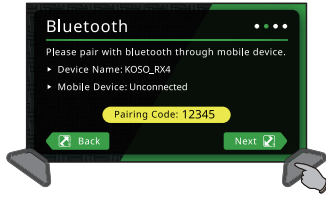

- Press the **Adjust** button for 3 seconds, enter the vehicle type screen.
- EX : Bluetooth® pairing screen completed.

**NOTE** iOS operating system:  
Need to enter the pairing code.  
Android operating system:  
No pairing code is required.  
Enter vehicle type selection directly.

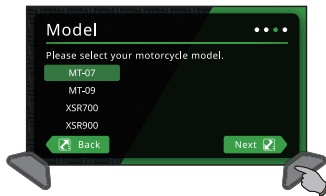

- EX : Select MT-07 for the vehicle type.
- Press the **Adjust** button for 3 seconds, enter the Corresponding No. screen of the Vehicle.

**NOTE** Refer to **3-1** Corresponding No. of the Vehicle.

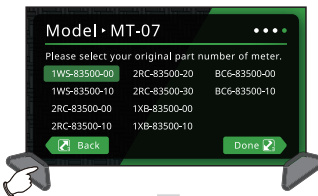

- Press the **Adjust** or **Select** button to choose the setting number.
- EX : To set Corresponding No. of the Vehicle to 2RC-83500-30.

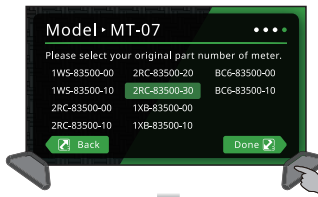

- Press the **Adjust** button for 3 seconds, enter the Vehicle condition screen.
- EX : Set Corresponding No. of the Vehicle from 1WS-83500-00 to 2RC-83500-30 .

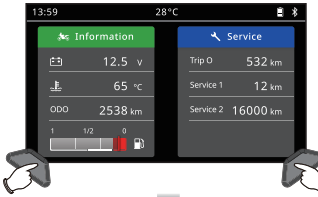

- Vehicle condition screen.
- Press the **Adjust + Select** buttons, to enter the main screen.



- The main screen.

## 4-2 Switching Instruction for Vehicle Condition Screen

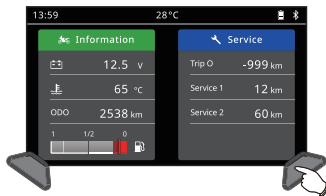

- In the Vehicle condition screen, press the **Adjust** button, to enter the Trip O screen (Flash).

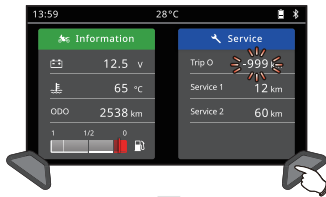

- In the Trip O screen (Flash), press the **Adjust** button to enter the Maintenance mileage 1 screen (Flash).
- Press the **Adjust** button for 3 seconds to reset Trip O screen.

Trip O -999 km → Trip O 500 km

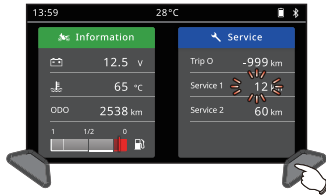

- In the Maintenance mileage 1 screen (Flash), press the **Adjust** button to enter the Maintenance mileage 2 screen (Flash).
- Press the **Adjust** button for 3 seconds to reset Maintenance mileage 1 screen (Flash).

Service 1 12 km → Service 1 500 km

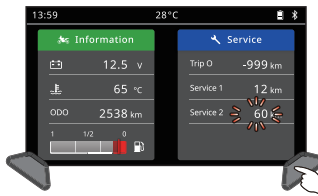

- In the Maintenance mileage 2 screen (Flash), press the **Adjust** button to enter the Vehicle condition screen.

- Press the **Adjust** button for 3 seconds to reset Maintenance mileage 2 screen (Flash).

Service 1 12 km → Service 1 500 km

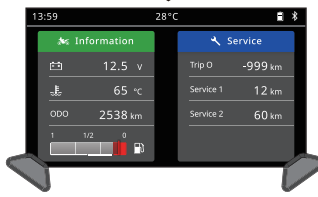

- The Vehicle condition screen.

### 4-3 Main Menu Switching Description(Adjust button)



- In the Trip 1 screen, press the **Adjust button** to enter the Trip 2 screen.
- Press the **Adjust button for 3 seconds** to reset Trip 1 record.

Trip 1 1688.9 km → Trip 1 0 km

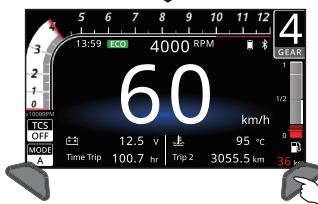

- In the Trip 2 screen, press the **Adjust button** to enter the Current fuel consumption screen.
- Press the **Adjust button for 3 seconds** to reset Trip 2 record.

Trip 2 3055.5 km → Trip 2 0 km

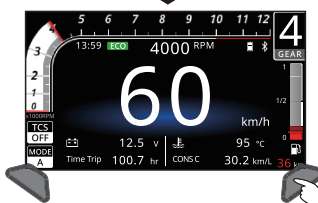

- In the Current fuel consumption screen, press the **Adjust button** to enter the Average fuel consumption screen.

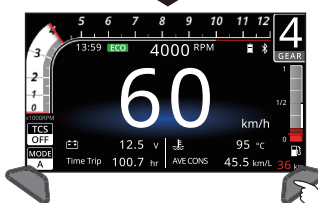

- In the Average fuel consumption screen, press the **Adjust button** to enter the Low fuel mileage screen.
- Press the **Adjust button for 3 seconds** to reset Average fuel consumption record.

AVE CONS 45.5 km/L → AVE CONS 0 km/L



- In the Low fuel mileage screen, press the **Adjust button** to enter the Max. record screen.
- Press the **Adjust button for 3 seconds** to reset Low fuel mileage record.



36 km → 0 km

**NOTE** A low fuel distance table is displayed when reaching the warning value for the original fuel gauge.

**NOTE** Automatically return to zero without display when filling up the tank and riding for 5km (3mile).



- In the Max. record screen, press the **Adjust button** to go back to the Trip 1 screen.
- Press the **Adjust button for 3 seconds** to reset Max. record.





- In the Trip 1 screen.

### 4-4 Main Menu Switching Description(Select button)



- In the Time Trip screen, press the **Select button** to enter the Time 1 screen.



- In the Time 1 screen, press the **Select button** to enter the Time 2 screen.
- Press the **Select button for 3 seconds** to reset Time 1 record.

Time 1 15.1 hr → Time 1 0 hr



- In the Time 2 screen, press the **Select button** to go back to the Time Trip screen.
- Press the **Select button for 3 seconds** to reset Time 2 record.

Time 2 18.3 hr → Time 2 0 hr

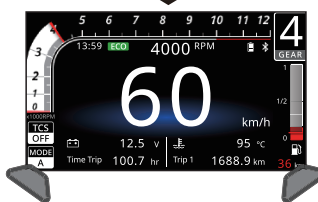

- In the Time Trip screen.

## 4-5 Record Screen Switching Description (Target Speed, Target Distance, Top Speed)



● In the main screen, press the **Select + Adjust** buttons to enter the target speed record screen.



● In the top speed record screen, press the **Select + Adjust** buttons to go back to the main screen.



● In the target speed record screen, press the **Select** button to enter the target distance record screen.

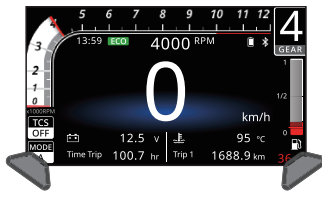

● In the main screen.



● In the target distance record screen, press the **Select** button to enter the top speed record screen.

● Regardless of the record screen, press the **Select** button for 3 seconds to enter the Power Test setting.

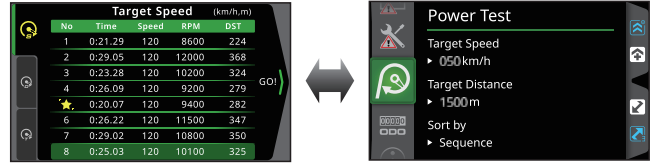

### 4-5-1 Description Of Target Speed Test



● In the target speed record screen, press the **Adjust** button to enter the testing screen.

**NOTE** Start the test when the bike is fully stopped.



● When you reach the target speed that you set (0~110 km/h), the timer will stop (19'20 second).

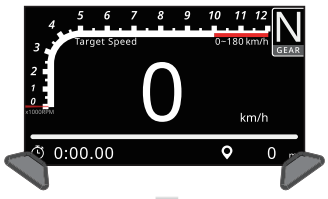

● In the testing screen.

**WARNING!** Use this function on racetracks to avoid accidents.

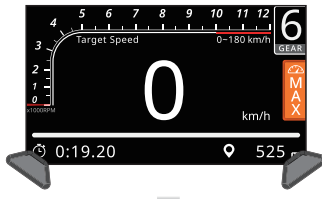

● When speed decreases to 0 km/h (MPH), the target speed record screen will appear.



● When the bike moves, the timer will start automatically.

**NOTE** The timer is automatic, so when your bike starts to move the timer will start to calculate the time and stop automatically when you stop the bike.



● In the target speed record screen.

● Press the **Adjust** button for 3 seconds, to reset the target speed record.



● Speed up.

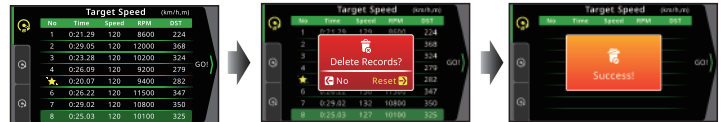

● Press the **Adjust** button to confirm deletion.  
● Press the **Select** button to cancel deletion.

● Successfully deleted.  
● The alert dialog will disappear after 3 seconds.

## 4-5-2 Description Of Target Distance Test



• In the target distance record screen, press the **Adjust** button to enter the testing screen.

**NOTE** Start the test when the bike is fully stopped.

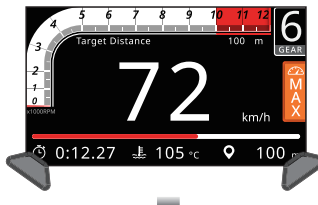

• When you reach the target distance that you set (100 M . 2/32 mile), the timer will stop (12"27 second).

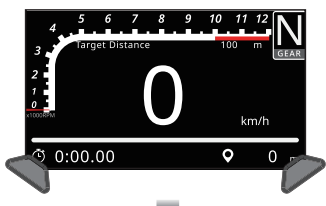

• In the testing screen.

**WARNING!** Use this function on racetracks to avoid accidents.

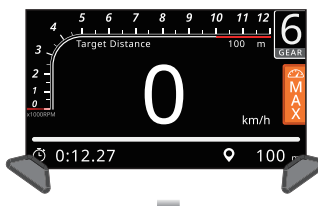

• When speed decreases to 0 km/h (MPH), the target distance record screen will appear.

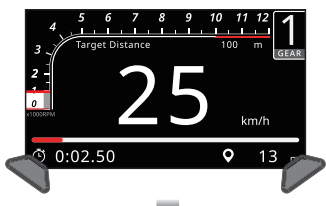

• When the bike moves, the timer will start automatically.

**NOTE** The product adopts digital sensing; when the vehicle starts, the timer will immediately start measuring. Upon achieving the target distance, the timer will immediately stop measuring.



• In the target distance record screen.

• Press the **Adjust** button for 3 seconds, to reset the target distance record.

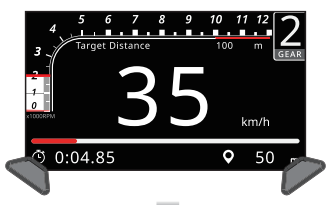

• Speed up.



• Press the **Adjust** button to confirm deletion.  
• Press the **Select** button to cancel deletion.

• Successfully deleted.  
• The alert dialog would disappear after displaying for 3 seconds.

## 4-5-3 Description Of Top Speed Test

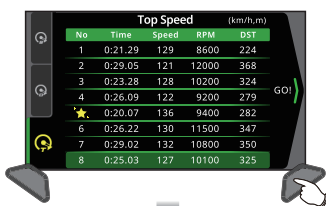

• In the top speed record screen, press the **Adjust** button to enter the testing screen.

**NOTE** Start the test when the bike is fully stopped.

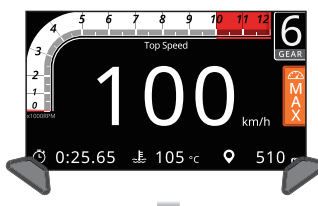

• When you reach the top speed (100 km/h), the meter will stop counting the distance (510 m), and time (25"65 seconds).

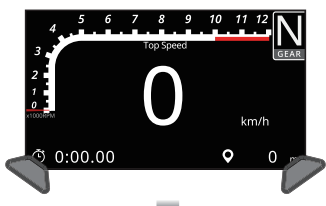

• In the testing screen.

**WARNING!** Use this function on racetracks to avoid accidents.

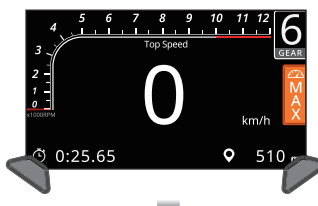

• When speed decreases to 0 km/h (MPH), the top speed record screen will appear.

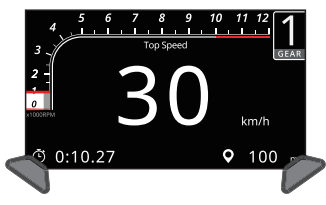

• When the bike moves, the timer will start automatically.

**NOTE** Display range(Top speed) :  
Speed : 0 ~ 360 km/h (0 ~ 225 MPH)  
Distance : 0 ~ 999 m (0~3,280 feet)  
Rotating speed : 0 ~ 15,000 RPM  
Time : 0 ~ 9'59"99

**NOTE** The product adopts digital sensing; when the vehicle starts, the odometer and the timer will immediately start measuring. Upon achieving the maximum speed, the odometer and the timer will immediately stop measuring.

⚠ To change the speed unit of the function go to 5-3 (Change in Speed Unit).



• In the top speed record screen.

• Press the **Adjust** button for 3 seconds, to reset the top speed record.

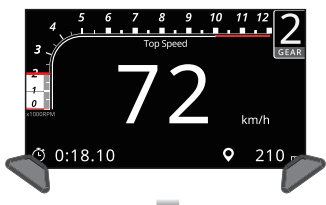

• Speed up.



• Press the **Adjust** button to confirm deletion.  
• Press the **Select** button to cancel deletion.

• Successfully deleted.  
• The alert dialog will disappear after 3 seconds.

## 5 Setting Screen Switching Description

- Press the **Select+Adjust buttons for 3 seconds** on the main screen, record screen, or vehicle condition screen to switch to the setting screen.
- Press the **Select button** or **Adjust button** to select
- ① Model ② Clock ③ Unit(Speed/Temperature/Fuel Consumption) ④ Backlight(Mode/Brightness/Color) ⑤ Speeding warning ⑥ Shift light warning
- ⑦ Voltage warning ⑧ Maintenance mileage ⑨ Power Test ⑩ Internal and External ODO
- ⑪ Meter information ⑫ Bluetooth®
- Press the **Adjust button for 3 seconds** to enter the setting function screen.
- In the setting screen, press the **Select button for 3 seconds** to switch to the startup screen.

**NOTE** During setting, if any button is not pressed for 3 minutes, it will automatically return to the startup screen.

• Main screen

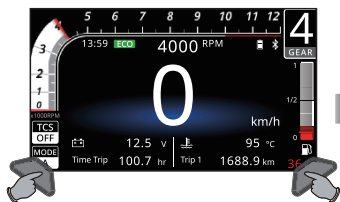

• Enter the setting screen.



① Model

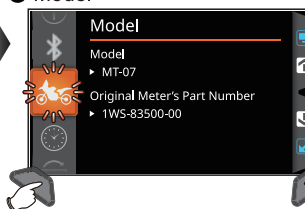

② Clock

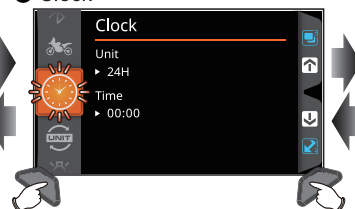

③ Unit(Speed/Temperature/  
Fuel Consumption)

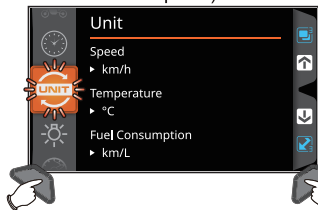

④ Backlight(Mode/Brightness/  
Color)



⑤ Speeding warning



⑥ Shift light warning



⑦ Voltage warning

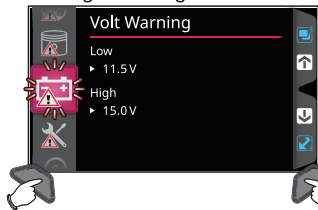

⑧ Maintenance mileage

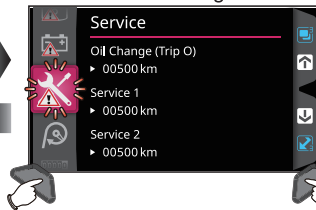

⑨ Power Test

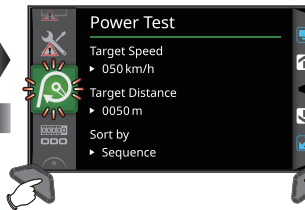

⑩ Internal and External ODO



⑪ Meter information



⑫ Bluetooth®





## 5-1 Model Setting

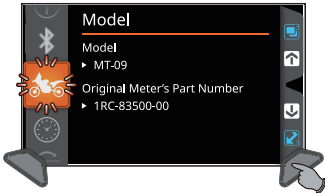

- The Model screen, press the **Adjust** button for 3 seconds to enter the Model setting.



- Press the **Select** button to choose the setting number.
- EX : To set Corresponding No. of the Vehicle to 2RC-83500-30

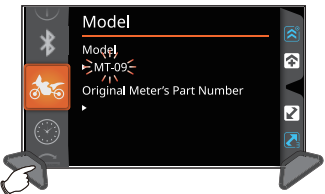

- Example** : To set mode to MT-07.
- Press the **Select** button to choose the setting options.

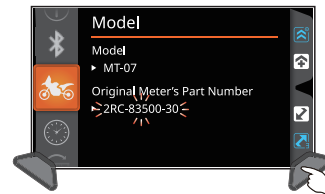

- Press the **Adjust** button to go back to the Model screen.
- EX : Set Corresponding No. of the Vehicle from 1WS-83500-00 to 2RC-83500-30.

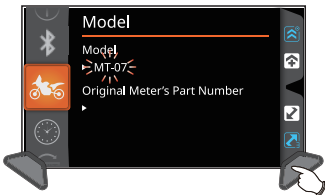

- Press the **Adjust** button, enter the Corresponding No. of the Vehicle screen.

**NOTE** Refer to 3-11 Corresponding No. of the Vehicle.

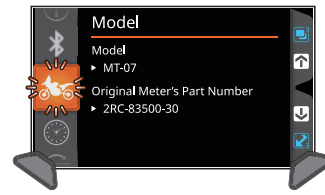

- The Model screen.

## 5-2 Clock Setting

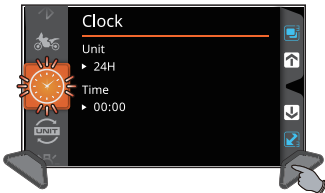

- The Clock screen, press the **Adjust** button for 3 seconds to enter the clock setting.

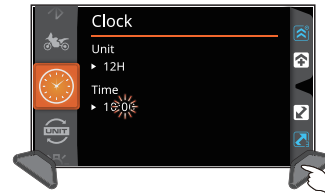

- Press the **Adjust** button to move to the digit you want to set.
- EX : To set clock(minute) as 10 minutes.

⚠ Now the setting value is flashing!

**NOTE** Setting range : 00~59 minutes.  
Default value : 0.

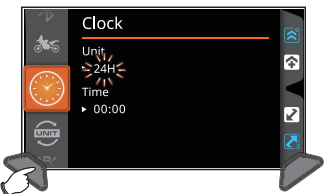

- Example** : Changing the 12H.
- Press the **Select** button to choose the setting number.

⚠ Now the setting value is flashing!

**NOTE** Setting range : 12 H, 24 H.  
Default value : 24 H.

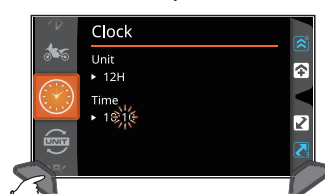

- Press the **Select** button to choose the setting number.



- EX : Set time format from 24 H to 12 H.
- Press the **Adjust** button to enter time adjustment hour setting.



- EX : Set minute from 0 minutes to 10 minutes.
- Press the **Adjust** button to go back to the clock screen.



- Example** : To set clock(hour) as 10 hours.
- Press the **Select** button to choose the setting number.

⚠ Now the setting value is flashing!

**NOTE** Cursor moving order is :  
Hour → Digit in ten minutes →  
Digit in minutes

**NOTE** Setting range : 1~12(12H)  
0 ~23(24H)  
Default value : 12(12H)/0(24H)

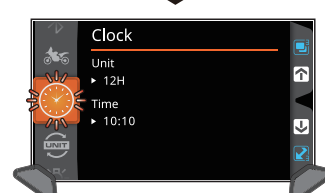

- The Clock screen.



- EX : Set hour from 12:00 AM to 10:00 AM.
- Press the **Adjust** button to enter clock adjustment minute setting.

### 5-3 Unit (Speed, Temperature, Fuel Consumption) Setting

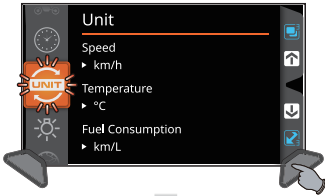

- The unit screen, press the **Adjust button** for 3 seconds to enter the speed unit setting.

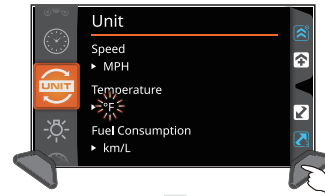

- EX : Set temp. unit from °C (Celsius) to °F (Fahrenheit).
- Press the **Adjust button** to enter the Fuel Consumption unit setting screen.

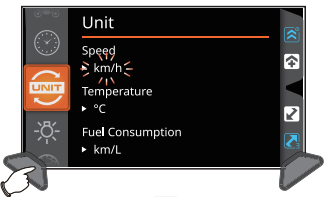

- Example : To set speed unit as MPH.**
- Press the **Select button** to choose the setting options.
- ⚠ Now the setting value is flashing!
- NOTE** Setting range : km/h, MPH. Default value : Subject to the vehicle type of the setting .

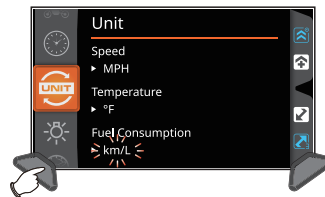

- Example : To set fuel consumption unit as L/100km.**
- Press the **Select button** to choose the setting options.
- ⚠ Now the setting value is flashing!
- NOTE** Setting range : km/L, L/100km, MPG(US), MPG(UK). Default value : Subject to the vehicle type of the setting .

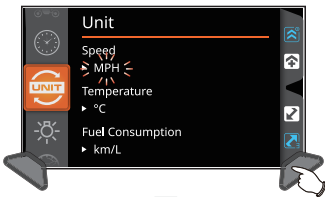

- EX : Set speed unit from km/h to MPH.
- Press the **Adjust button** to enter the temp. unit setting screen.

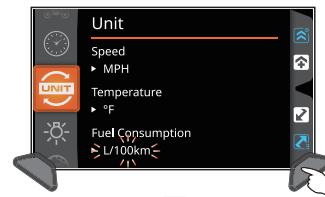

- EX : Set fuel consumption unit from km/L to L/100km.
- Press the **Adjust button** to go back to the unit (speed, temp., fuel consumption) screen.

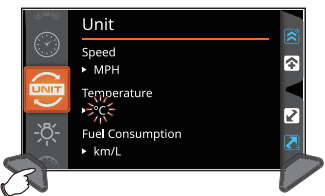

- Example : To set temp. unit to °F.**
- Press the **Select button** to choose the setting options.
- ⚠ Now the setting value is flashing!
- NOTE** Setting range : °C (Celsius) and °F (Fahrenheit). Default value : Subject to the vehicle type of the setting .

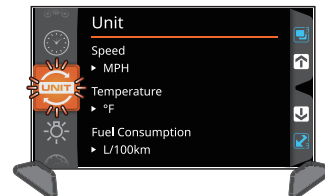

- The unit (speed, temp., fuel consumption) screen.

### 5-4 Backlight (Mode/Brightness/Color) Setting

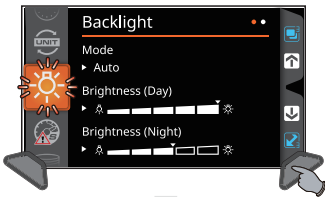

- The backlight screen, press the **Adjust button** for 3 seconds to enter the background mode setting.



- Example : To set the backlight brightness (day) to 4/5 (80%).**
- Press the **Select button** to choose the setting number.
- ⚠ Now the setting value is flashing!
- NOTE** Setting range : 1/5 (Darkest) ~ 5/5 (Brightest). Default value : 5/5 (100%).

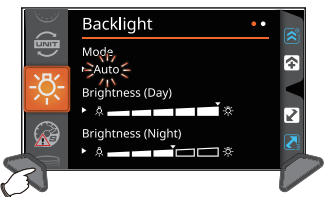

- Example : To set the mode to Night mode.**
- Press the **Select button** to choose the setting options.
- ⚠ Now the setting value is flashing!
- NOTE** Setting Auto (automatically switch according to the light : day mode display for a bright environment and Night mode display for a dark environment), Day mode, Night mode. Default value : Auto.

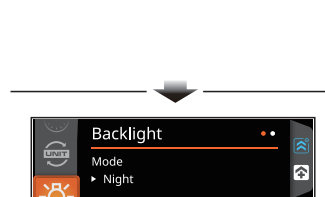

- NOTE** The backlight brightness will change immediately after you set the value.



- EX : Set background from Auto mode to Night mode.
- Press the **Adjust button** to enter the backlight brightness (day) setting.



- Example : To set the backlight brightness (night) to 2/5 (40%).**
- Press the **Select button** to choose the setting number.
- ⚠ Now the setting value is flashing!
- NOTE** Setting range : 1/5 (Darkest) ~ 5/5 (Brightest). Default value : 3/5 (60%).
- NOTE** The backlight brightness will change immediately after you set the value.

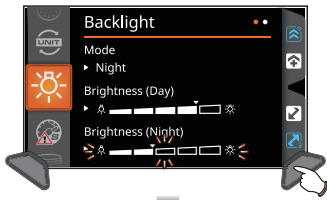

- EX : The backlight brightness (night) setting is changed from 3/5 (60%) to 2/5 (40%).
- Press the **Adjust button** to enter the backlight color setting.

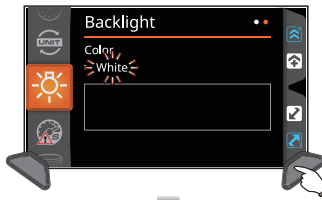

- EX : Set backlight color from blue to white.
- Press the **Adjust button** to go back to the backlight screen.

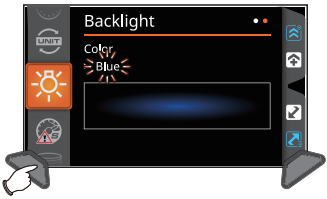

- Example** : To set backlight color to white.
- Press the **Select button** to choose the color .

⚠ Now the setting value is flashing!

**NOTE** Switch color according to the following order, blue, green, orange, white.

**NOTE** Default value : blue.

**NOTE** The backlight color will change immediately after you set the value.



- The backlight screen.

## 5-5 Speed warning Setting

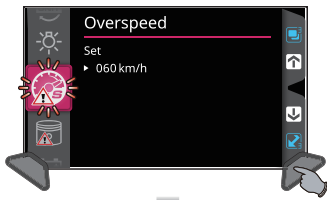

- The Speed warning screen, press the **Adjust button for 3 seconds** to enter the speeding warning setting.

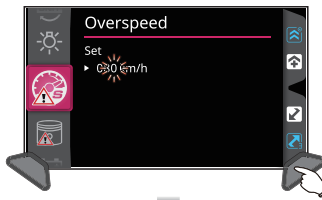

- EX : Set speed warning value from 60 km/h to 80 km/h.
- Press the **Adjust button** to go back to the speed warning screen.

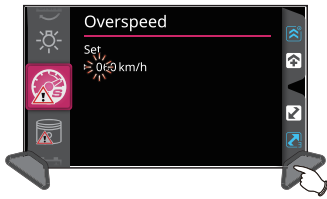

- Example** : To set speed warning value to 80 km/h.
- Press the **Adjust button** to move to the digit you want to set.

⚠ Now the setting value is flashing!

**NOTE** Setting range : 30~360 km/h (20~225 MPH).  
Default value : 60 km/h (38 MPH).

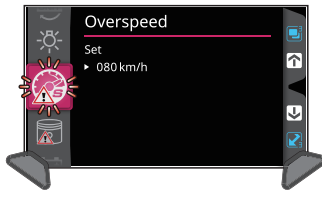

- The speed warning screen.

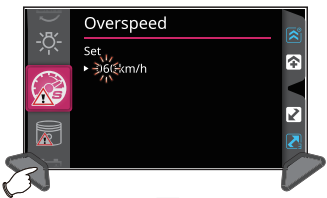

- Press the **Select button** to choose the setting number.

## 5-6 Shift light warning Setting

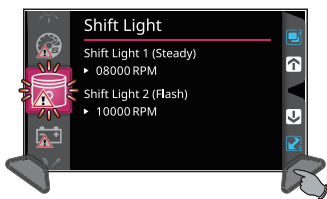

- The shift light warning screen, press the **Adjust button for 3 seconds** to enter the shift light warning(Steady) setting.

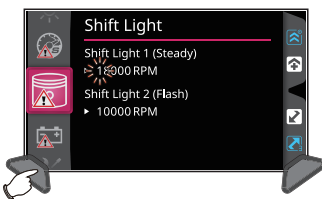

- Press the **Select button** to choose the setting number.

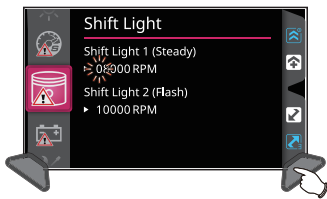

- Example** : To set shift light warning (Steady) value to 12,000 RPM.
- Press the **Adjust button** to move to the digit you want to set.

⚠ Now the setting value is flashing!

**NOTE** Setting range :  
[MT-07] : 1,000 ~ 12,000 RPM  
[MT-09] : 1,000 ~ 13,000 RPM  
[XSR700] : 1,000 ~ 12,000 RPM  
[XSR900] : 1,000 ~ 13,000 RPM  
Default value : Subject to the vehicle type of the setting .

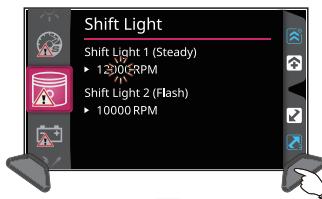

- EX : Set shift light warning(Steady) value from 8,000 RPM to 12,000 RPM.
- Press the **Adjust button** to enter the shift light warning(Fast Flash) setting.



- **Example** : To set shift light warning (Flash) value to 11,000 RPM.
- Press the **Adjust button** to move to the digit you want to set.

⚠ Now the setting value is flashing!

**NOTE** Setting range :  
 [MT-07] : 1,000 ~ 12,000 RPM  
 [MT-09] : 1,000 ~ 13,000 RPM  
 [XSR700] : 1,000 ~ 12,000 RPM  
 [XSR900] : 1,000 ~ 13,000 RPM  
 Default value : Subject to the vehicle type of the setting .

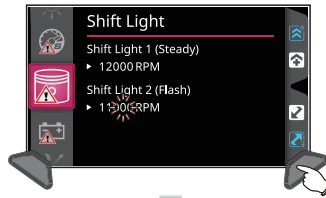

- **EX** : Set shift light warning(Flash) value from 10,000 RPM to 11,000 RPM.
- Press the **Adjust button** to go back to the shift light warning screen.



- The shift light warning screen.



- Press the **Select button** to choose the setting number.

## 5-7 Voltage warning Setting

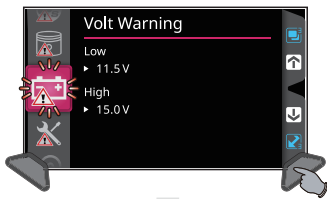

- The voltage warning screen, press the **Adjust button for 3 seconds** to enter the low voltage warning setting.

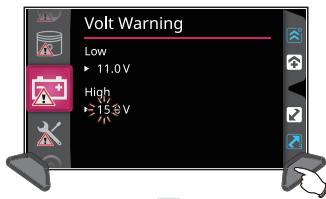

- **Example** : To set high voltage warning value to DC 16.0 V.
- Press the **Adjust button** to move to the digit you want to set.

⚠ Now the setting value is flashing!

**NOTE** Setting range : DC 13.1~18.0 V.  
 Default value : DC 15.0 V.

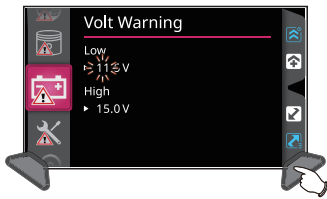

- **Example** : To set low voltage warning value to DC 11.0 V.
- Press the **Adjust button** to move to the digit you want to set.

⚠ Now the setting value is flashing!

**NOTE** Setting range : DC 8.0~13.0 V.  
 Default value : DC 11.5 V.

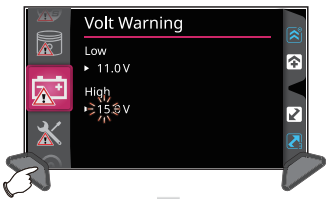

- Press the **Select button** to choose the setting number.

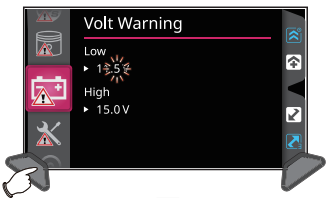

- Press the **Select button** to choose the setting number.

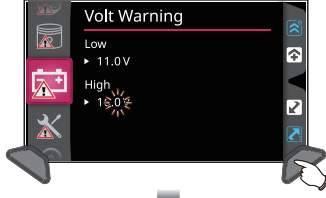

- **EX** : Set high voltage warning value from DC 15.0 V to DC 16.0 V.
- Press the **Adjust button** to go back to the voltage warning screen.

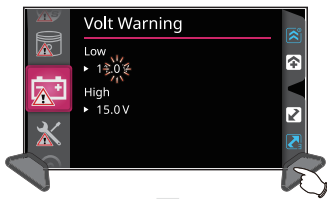

- **EX** : Set low voltage warning value from DC 11.5 V to DC 11.0 V.
- Press the **Adjust button** to enter the high voltage warning setting.

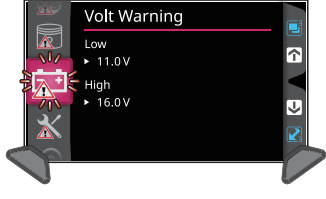

- The voltage warning screen.

## 5-8 Maintenance mileage Setting

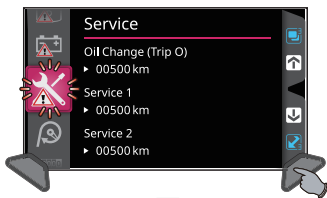

- The maintenance mileage screen, press the **Adjust button for 3 seconds** to enter the motor oil maintenance setting.

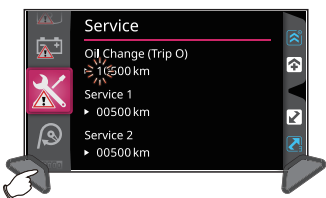

- Press the **Select button** to choose the setting number.

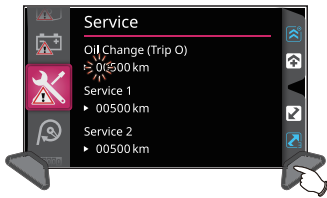

- **Example** : To set motor oil maintenance as 12,000 km.
- Press the **Adjust button** to move to the digit you want to set.

⚠ Now the setting value is flashing!

**NOTE** Setting range : 500 ~ 16,000 km  
 (300~10,000 mile).  
 Default value : 500 km(300 mile).

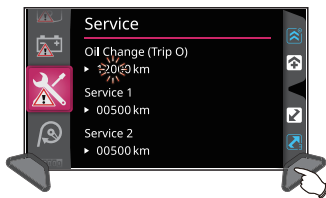

- **EX** : The motor oil maintenance setting is changed from 500 km to 12,000 km.
- Press the **Adjust button** to enter the maintenance mileage 1 setting.

●**Example : To set maintenance mileage 1 as 10,000 km.**  
 ●Press the **Adjust button** to move to the digit you want to set.

⚠ **Now the setting value is flashing!**

**NOTE** Setting range : 500 ~ 16,000 km (300~10,000 mile).  
 Default value : 500 km(300 mile).

●Press the **Select button** to choose the setting number.

●EX : The maintenance mileage 1 setting is changed from 500 km to 10,000 km.  
 ●Press the **Adjust button** to enter the maintenance mileage 2 setting.

●**Example : To set maintenance mileage 2 as 8,000 km.**  
 ●Press the **Adjust button** to move to the digit you want to set.

⚠ **Now the setting value is flashing!**

**NOTE** Setting range : 500 ~ 16,000 km (300~10,000 mile).  
 Default value : 500 km(300 mile).

●Press the **Select button** to choose the setting number.

●EX : The maintenance mileage 2 setting is changed from 500 km to 8,000 km.  
 ●Press the **Adjust button** to go back to the maintenance mileage screen.

●The maintenance mileage screen.

## 5-9 Power Test Setting

●The Power Test screen, press the **Adjust button for 3 seconds** to enter the Power Test setting.

●**Example : To set target speed value to 110 km/h.**  
 ●Press the **Adjust button** to move to the digit you want to set.

⚠ **Now the setting value is flashing!**

**NOTE** Setting range : 30~360 km/h (20~225 MPH).  
 Default value : 50 km/h (30 MPH).

●Press the **Select button** to choose the setting number.

●EX : Set target speed value from 50 km/h to 110km/h.  
 ●Press the **Adjust button** to enter the target distance setting.

●**Example : To set target distance value to 100 m.**  
 ●Press the **Adjust button** to move to the digit you want to set.

⚠ **Now the setting value is flashing!**

**NOTE** Setting range : 50~1,500 m (1/32~30/32 mile).  
 Default value : 50 m (1/32 mile).

●Press the **Select button** to choose the setting number.

●EX : Set target distance value from 50 m to 100 m.  
 ●Press the **Adjust button** to enter the record order setting.

●**Example : To set record order to Best.**  
 ●Press the **Select button** to choose the setting options.

⚠ **Now the setting value is flashing!**

**NOTE** Setting range : Sequence, Best.  
 Default value : Sequence.



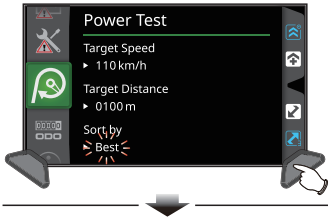

- EX : Set record order from Sequence to Best.
- Press the **Adjust** button to go back to the Power Test screen.

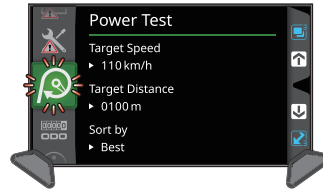

- The Power Test screen.

## 5-10 Internal and External ODO Setting

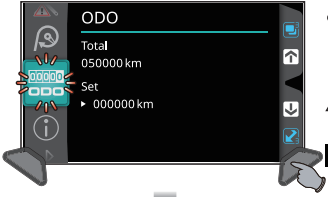

- The internal and external ODO screen, press the **Adjust** button for 3 seconds to enter the external ODO setting.

⚠ User unable to adjust or clear internal ODO.

**NOTE** Display range :0~999,999 km (mile).

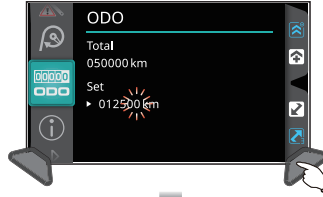

- EX : Set external total distance value from 000,000 km to 12,500 km.
- Press the **Adjust** button to go back to the internal and external ODO screen.

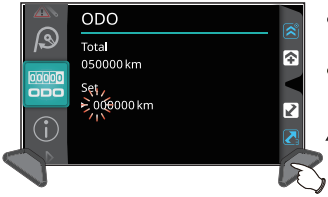

- Example : To set external total distance value to 12,500 km.

- Press the **Adjust** button to move to the digit you want to set.

⚠ Now the setting value is flashing!

Cursor's order : one hundred thousand→thousands→thousand→hundred→ten→digit.

**NOTE** Setting range : 0 ~ 999,999 km (mile).

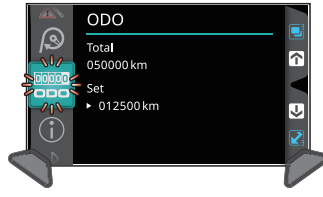

- The internal and external ODO screen.



- Press the **Select** button to choose the setting number.

## 5-11 Meter information Setting

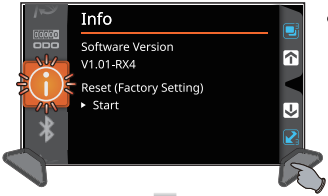

- The meter information screen, press the **Adjust** button for 3 seconds to enter the meter information setting.

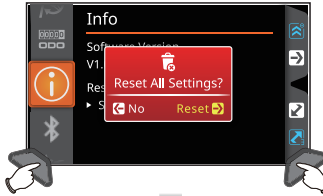

- Press the **Adjust** button to confirm reset.
- Press the **Select** button to cancel reset.

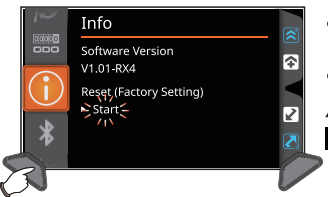

- Example : To reset the meter(original setting).

- Press the **Select** button to reset.

⚠ Now the setting value is flashing!

**NOTE** User unable to adjust or clear software Version.

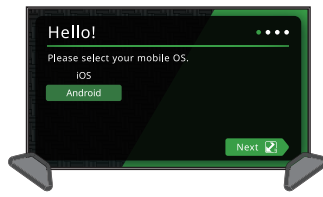

- Successfully reset and return to the boot screen for initial use.

## 5-12 Bluetooth® Setting



- The Bluetooth® screen, press the **Adjust button for 3 seconds** to enter the Bluetooth® setting.



- Example : Select "ON" or "OFF" for the Bluetooth® setting.**
- Press the **Select button** to choose the setting options.
- If OFF is selected, then press the **Adjust button** to exit the Bluetooth® setting.
- If ON is selected, then press the **Adjust button** to enter the mobile operating system settings.

⚠ **Now the setting value is flashing!**

**NOTE** Setting range : ON, OFF.  
Default value : ON.

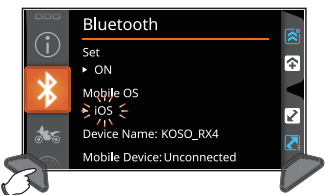

- Example : To set mobile operating system to iOS.**
- Press the **Select button** to choose the setting options.

⚠ **Now the setting value is flashing!**

**NOTE** Setting range : iOS, Android, Supported version: iOS 5.0 and above, Android 9 and above. Default value : iOS.

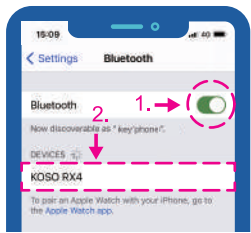

- Turn on the Bluetooth® function of the mobile phone.
- Press device "KOSO RX4."

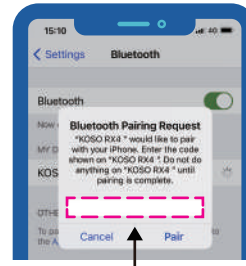

- Enter the code displayed on "KOSO RX4."

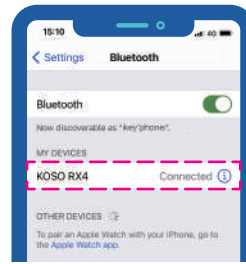
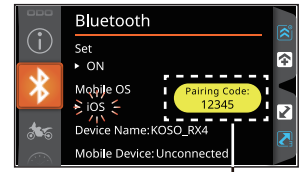

- Device successfully connected.



- EX : Bluetooth® successfully connected.
- Press the **Adjust button** to go back to the Bluetooth screen.



- The Bluetooth® screen.
- NOTE** After the Bluetooth® is successfully connected, the main screen may display the battery, incoming phone call notice, incoming online call notice, music playing message, information of the mobile phone.

### Phone battery

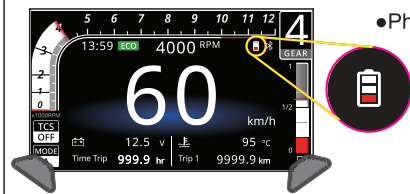

- Phone battery.

**NOTE** Display range : 3 bars.

### Push notification



- Push notification screen.

**NOTE** Display range :  
Name - 4 letters, and "... " is displayed for more than 4 letters.  
Content - 17 letters, and "... " is displayed for more than 17 letters.  
→ iOS supported, not Android.

## Incoming phone call notice/ Incoming online call notice

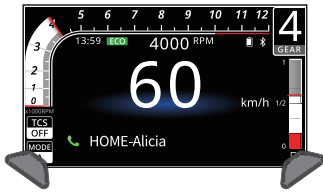

- Incoming phone call notice screen.
- Incoming online call notice screen.

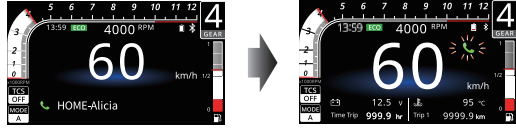

- Call connected screen.

### NOTE ● Incoming phone call notice screen.

Display range : Display name or number for up to 12 letters; "... " is displayed if > 12 letters;  
"Unknown" is displayed when there is no name  
iOS - Display either name or number of the incoming call  
Android - Display number only

### ● Incoming online call notice screen.

Display range : Display name for up to 12 letters;  
"... " is displayed if > 12 letters;  
"Unknown" is displayed when there is no name  
→ Support LINE, WeChat, WhatsApp  
→ iOS supported, not Android.

## Music playing info



- Music playing info screen.

### NOTE

Song title: 15 letters, and "... " displayed if > 15 letters  
Artist name: 18 letters, and "... " displayed > 18 letters  
Total length of the song : 00:00 ~ 9:59:59,  
"9:59:59" displayed if longer.  
→ iOS supported, not Android.  
Current playing time : 00:00 ~ 9:59:59,  
"9:59:59" is displayed if longer.  
→ Support iOS supported, not Android.

※ "The Company is committed to optimizing the Bluetooth® application function of the meter. However, as supports for software and hardware are different as mobile phones differ, the Bluetooth® application function of the meter may be affected, causing differences in functions."

## 6 Trouble Shooting

The following situations do not necessarily indicate malfunction of the product. Check the following points, before contacting us.

Trouble	Check item	Trouble	Check item
The meter doesn't work when the power is on.	<ul style="list-style-type: none"> <li>● The power isn't supplied to the meter. → Make sure the wiring is connected. The wiring and fuse are not broken.</li> <li>→ The battery is too old to supply needed power (DC 12 V).</li> </ul>	Fuel meter doesn't display or display error.	<ul style="list-style-type: none"> <li>● Check your fuel tank.</li> <li>● May be due to poor connection of wiring. → Check whether the wires are disconnected or have fallen off.</li> <li>● May be wrong settings. → Check the 3-1 Corresponding No. of the Vehicle.</li> </ul>
The meter shows wrong information.	<ul style="list-style-type: none"> <li>● Check the voltage of your battery, and make sure the voltage is over DC 12 V.</li> </ul>	The clock is incorrect.	<ul style="list-style-type: none"> <li>● May be wrong setting. → Check the setting list to see whether the setting for clock is correct.</li> </ul>
Speed meter doesn't appear or appears incorrectly.	<ul style="list-style-type: none"> <li>● May be due to poor connection of wiring. → Check whether the wires are disconnected or have fallen off.</li> <li>● May be wrong settings. → Check the 3-1 Corresponding No. of the Vehicle.</li> </ul>	Voltage doesn't appear or appears incorrectly.	<ul style="list-style-type: none"> <li>● May be due to poor connection of wiring. → Check whether the wires are disconnected or have fallen off.</li> </ul>
Tachometer doesn't appear or appears incorrectly.	<ul style="list-style-type: none"> <li>● May be due to poor connection of wiring. → Check whether the wires are disconnected or have fallen off.</li> <li>● May be wrong settings. → Check the 3-1 Corresponding No. of the Vehicle.</li> </ul>	The meter indicator didn't display.	<ul style="list-style-type: none"> <li>● May be due to poor connection of wiring. → Check whether the wires are disconnected or have fallen off.</li> </ul>
Thermometer doesn't appear or appear incorrectly.	<ul style="list-style-type: none"> <li>● May be wrong settings. → Check the 3-1 Corresponding No. of the Vehicle.</li> </ul>		

※ If the problems still can't be solved, contact our technical department for assistance.

Android™ is a registered trademark of Google LLC. Apple® and iPhone® is a trademarks of Apple Inc., registered in the U.S. and other countries. The Bluetooth® word mark and logos are registered trademarks owned by Bluetooth SIG, Inc. and any use of such marks by Tong Yah Electronic Technology Co.,Ltd is under license. Other trademarks and trade names are those of their respective owners.