

MOTOPLASTIC, S.A.

Molí de la sal, 1 - 08403 Granollers (Barcelona) SPAIN

Tel. 34 93 849 06 33 - Fax 34 93 849 09 88

info@puig.tv - info@puigusa.com





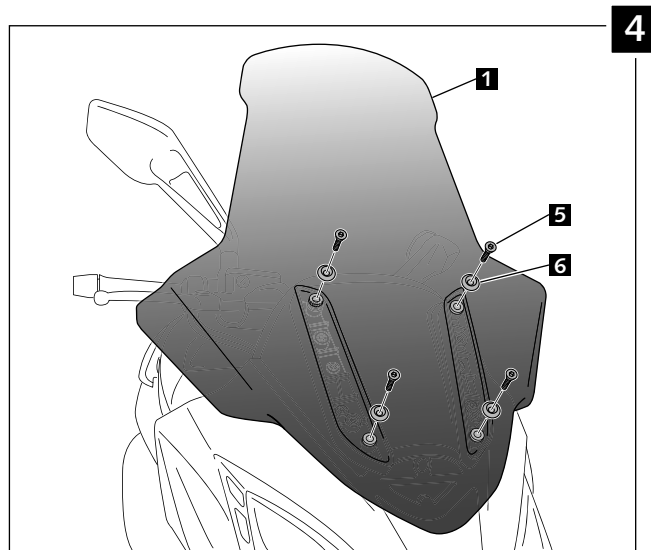
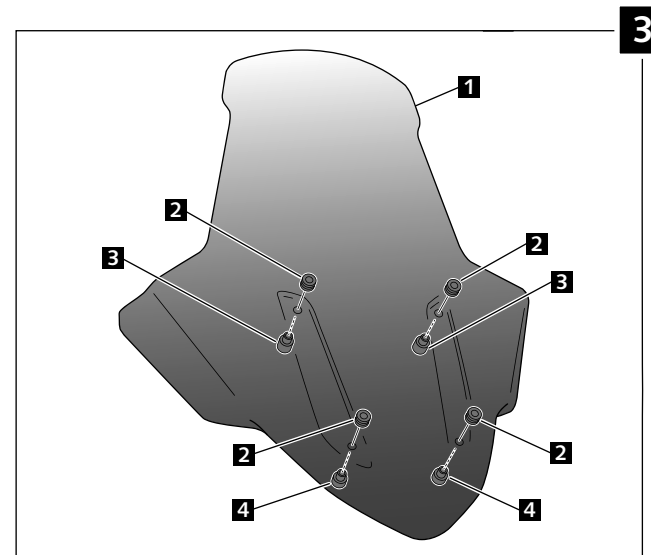
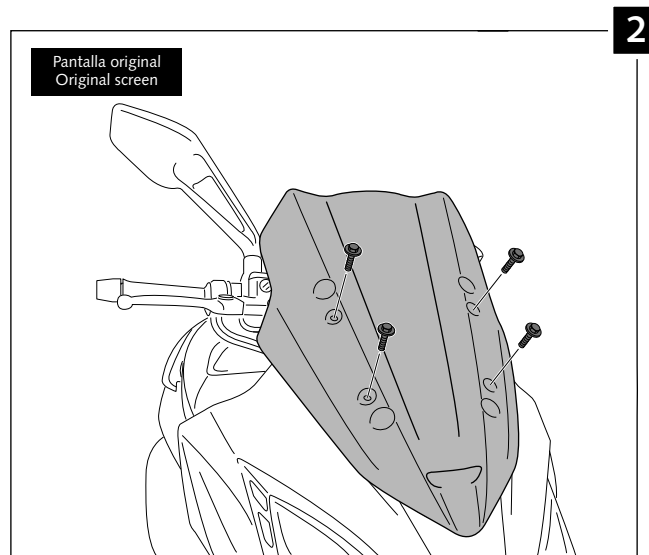
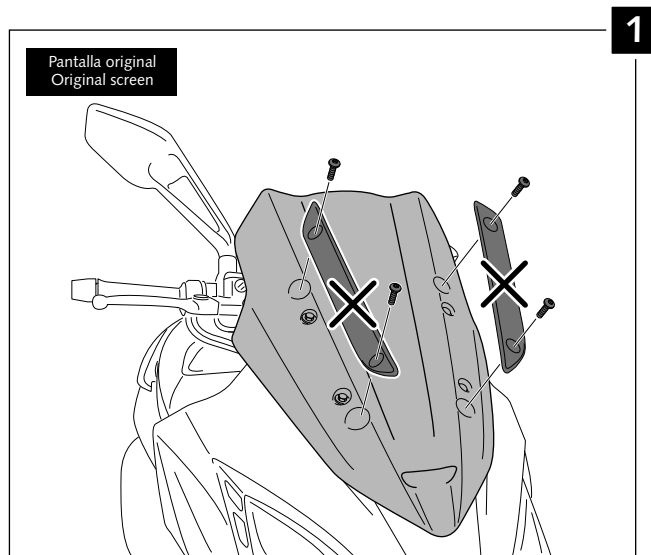

www.puig.tv - www.puigusa.com

INSTRUCCIONES DE MONTAJE - MOUNTING INSTRUCTIONS

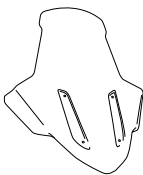
PANTALLA ADAPTABLE A – WINDSCREEN FOR KYMCO XCITING 400

Ref.: 6034



ID.	DESCRIPCIÓN	DESCRIPTION	QTY.
1	 Pantalla	Windscreen	1
2	 Silemblock	Silemblock	4
3	 Casquillo con valona (Øint) 6,4 x (Øext.1) 9 x (Øext.2) 18 x 19,5mm	Bush with flange (Øint) 6,4 x (Øext.1) 9 x (Øext.2) 18 x 19,5mm	2
4	 Casquillo con valona (Øint) 6,4 x (Øext.1) 9 x (Øext.2) 18 x 16,5mm	Bush with flange (Øint) 6,4 x (Øext.1) 9 x (Øext.2) 18 x 16,5mm	2
5	 Arandela cónica Ø20	Conic Ø20 Washer	4
6	 Tornillo cónico DIN 7991 M6x35	DIN 7991 M6x35 Conic screw	4