



Thank you for purchasing **KOSO dual EGT meter**, before operating the unit, please read the instruction thoroughly and retain it for the future reference.

## Notice

1. The lcd meter is apply for **DC 12V**.
2. For installation, please follow the steps described in manual. Any damage caused by wrong installation shall be imputed to the users.
3. To avoid the short circuit, please don't pull the wire when installing. Don't break or modify the wire terminal.
4. Do not disassemble or change any parts excluding the manual description.
5. The interior examination or maintenance should be executed by our professionals.

## MARK MEANING:

**NOTE** You could get the installation details from the information behind the mark.

△ Some processes must be followed to avoid the affection caused by wrong installation.

⚠ **WARNING!** Some processes must be followed to avoid damages to yourself or the public.

⚠ **CAUTION!** Some processes must be followed to avoid the damage to the vehicle.

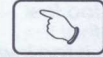

PRESS THE  
BUTTON ONE TIME



PRESS THE  
BUTTON 3  
SECONDS

## 1 Accessory

<b>1</b> LCD meter X 1 	<b>2</b> Main wire X 1 	<b>3</b> EGT temperature sensor X 2 	<b>4</b> Stainless clamp X 2 
<b>5</b> Connect terminal X 1 	<b>6</b> Meter bracket X 1 	<b>7</b> Rubber X 1 	<b>8</b> Rubber X 1 
<b>9</b> Steel gasket X 1 	<b>10</b> M4 X 14L screw X 2 	<b>11</b> M5 X 18L screw X 2 	<b>12</b> M4 washer X 2 (A) M5 washer X 2 (B) 
<b>13</b> M4 X P0.8 nut X 2 	<b>14</b> M3 spanner X 1 	<b>15</b> M4 spanner X 1 	

**NOTE** Please contact the local distributor if the items you open are not the same, with the above-listed one.

## 2-1 Wiring installation instructions

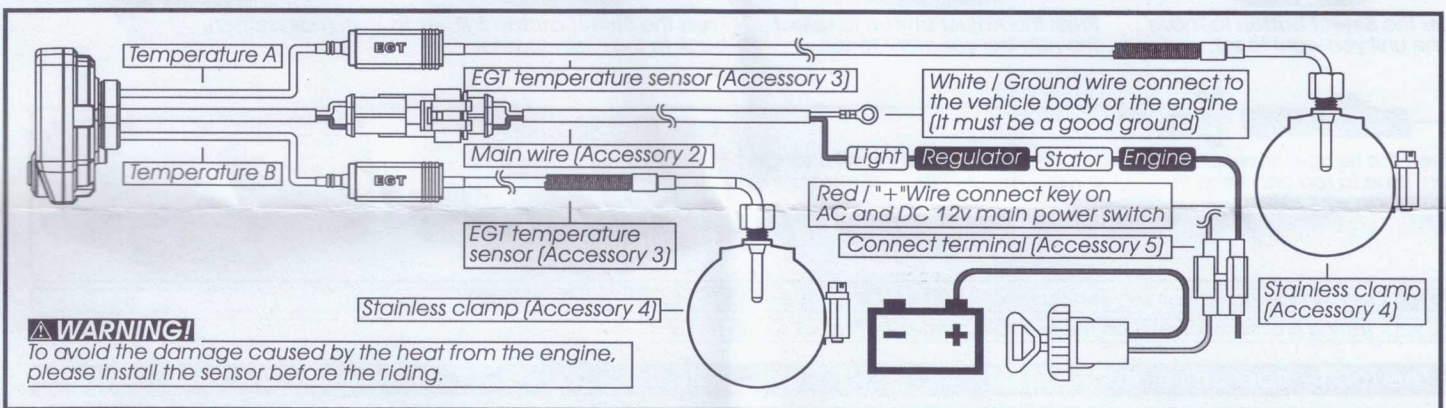

## 2-2 Installation instructions

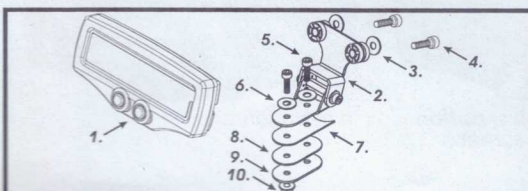

When installing, please follow the process.

1. LCD meter (Accessory 1)
2. Meter bracket (Accessory 6)
3. M5 gasket X 2 (Accessory 12-B)
4. M5 X 18L screw X 2 (Accessory 11)
5. M4 X 14L screw X 2 (Accessory 10)
6. M4 gasket X 2 (Accessory 12-A)
7. Rubber (Accessory 7)
8. Rubber (Accessory 8)
9. Steel gasket (Accessory 9)
10. M4 X P0.8 nut X 2 (Accessory 13)

### 3-1 Basic function instruction

#### Select button

● In main screen, press down the **Select button** to switch °C to °F.



#### Adjust button

● In main screen, press down the **Adjust button** switch thermometer to top thermometer record.



#### Over temperature warning

● Setting range: 200~1000°C (392~1832°F).  
● Setting unit: 1°C (°F).  
> Regarding the setting, please check 4.



#### No signal!

● Please check the signal wiring situation. If the signal wiring is broken or falling off, the meter will display the wrong data or nothing like the example above.



#### Temperature too low

● --L-- means that the temperature is too low to defect. <100°C (250°F)



#### Temperature too high

● --H-- means that the temperature is too high to defect. >1200°C (2100°F)



#### Select button X 3 seconds

● In top thermometer record, press down the **Adjust button** for 3 seconds to reset the record.  
> Regarding the setting, please check 5.



### 3-2 Function, setting instruction

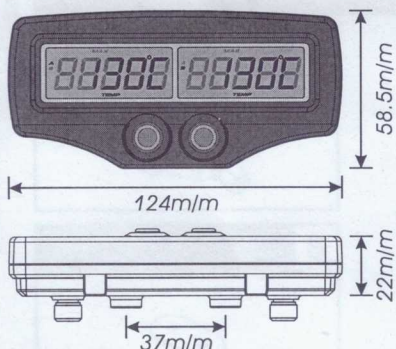

● Temperature A.B	Display range: 100~1200°C (250~2100°F) · Display unit: 1°C (°F)
○ Over temperature warning setting	Setting range: 200~1000°C (392~1832°F) · Setting unit: 1°C (°F)
○ Top temperature record	Display range: 100~1200°C (250~2100°F) · Display unit: 1°C (°F)
○ Display internal	<0.5 second
● Effective voltage	DC 12V
● Effective temperature range	-10~+60°C
● Meter standard	JIS D 0203
● Meter size	W124 X L58.5 X H22 mm
● Meter weight	Around 170 g

**NOTE** Design and specifications are subject to change without notice!

### 4 Over temperature warning setting



In main screen, press down the **Select & Adjust button for 3 seconds** to enter the over temperature A warning setting screen.



Press the **Select button** to move to the unit you want to set.



Press the **Adjust button** to select the number you want to set.



Press the **Select button** 3 times to enter the temperature B warning setting screen.



Press the **Select button** to move to the unit you want to set.

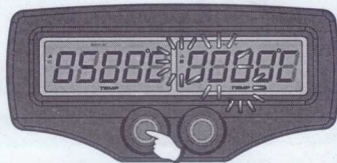

Press the **Adjust button** to select the number you want to set.

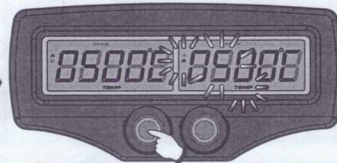

Press the **Select button** 3 times to back to the main screen.

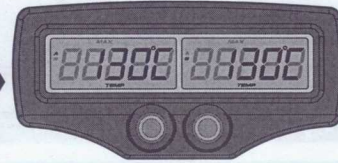

In main screen.

P.S.



When the temperature reaches your setting, the back light will change from blue to red and keep flashing to warn you until the temperature is lower than your setting.



**NOTE** Over temperature warning Setting range: 200~1000°C (392~1832°F) · Setting unit: 1°C (°F)

▲ If your setting is over or lower than the settable range, it will back to the first unit.

### 5 The top temperature record reset



In main screen, press the **Adjust button** to display the top record.



Press down the **Adjust button** for 3 seconds to reset the record.



After it, press the **Adjust button** to back to the main screen.



In main screen.

# EGT sensor instructions

The temperature indicated on your gauge is the temperature at the tip of your exhaust sensor. This temperature is different for each sleds on the market. An engine should never be tune by exhaust temperature alone. The exhaust gas temperatures are a great tuning aid but they are not the final word. The normal temperature range for most sleds will range between 593 °C and 676 °C depending on the engine set up. The temperature indicated should always be correlated with the piston and plug color. Generally, probe location should be between 10 cm to 15 cm from the piston skirt out.

**Each sled and exhaust systems manufacturer have their own specifications for probe location and running temperature. To be more precise, these manufacturing companies should be contacted for all the details needed.**

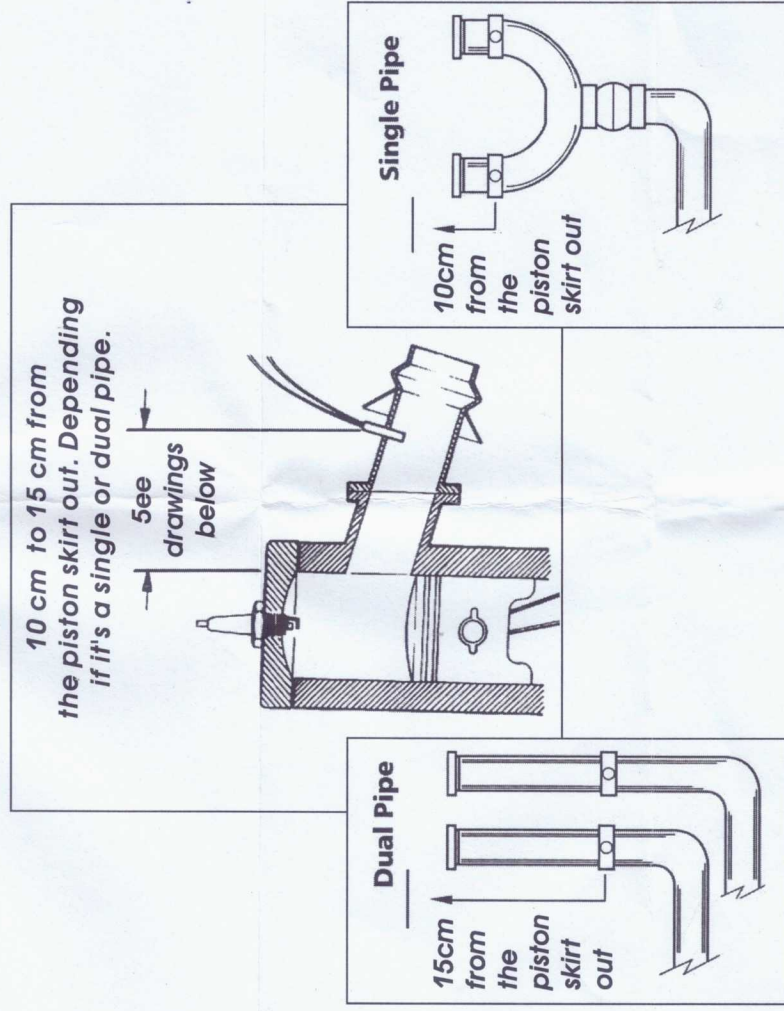

70944 NO.406 DING-ANN ST. ANNAN DISTRICT TAINAN TAIWAN R.O.C  
TEL + 886-6-2556565 FAX + 886-6-2461878  
Http [www.koso.com.tw](http://www.koso.com.tw)  
e-mail [koso9981@ms34.hinet.net](mailto:koso9981@ms34.hinet.net)